

Windows and balcony doors - ELITE 92

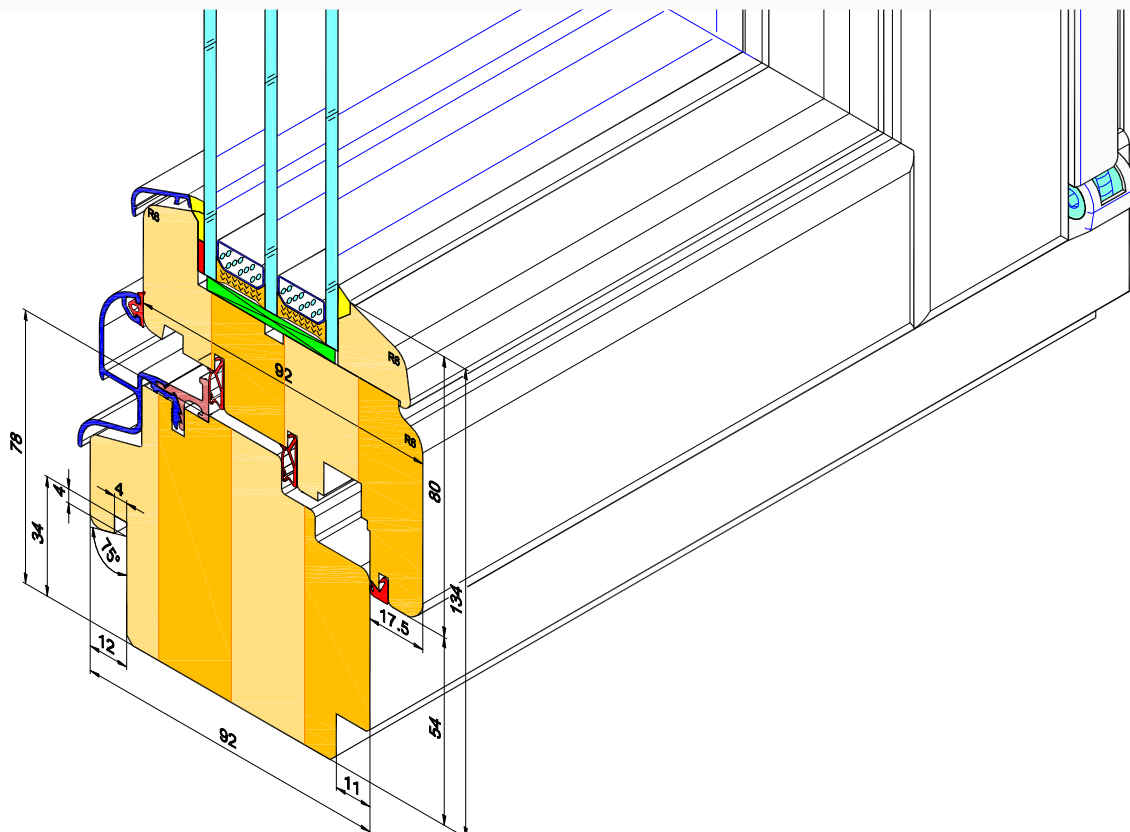

	<i>technical issue</i>	<i>description</i>	<i>notes</i>
1	CONSTRUCTION	ELITE 92	
2	MATERIAL	<ul style="list-style-type: none"> - pine fingerjointed, - pine sorted (not fingerjointed), - meranti, - oak, 	
3	FITTINGS OPTIONS	<ul style="list-style-type: none"> - tilt, turn, turn&tilt, tilt&turn, - flying mullion with espagnolette, - tilt with HAU-TAU opener (from floor level), - anti-burglar options: RC1, RC2, - tilt and slide, - balcony doors with low aluminium threshold, - hidden hinges, - TBT handle function (tilt before turn), <li style="padding-left: 20px;">Balcony doors outward opening 	
4	WINDOW SHAPE	<ul style="list-style-type: none"> - rectangle, - triangle, - trapezium, - rounded, - arched, 	
5	SIZE RANGES	<p style="text-align: center;">Sash width</p> <ul style="list-style-type: none"> - standard: 332 - 1547mm, - RC1: 396 - 1761mm, - RC2: 396 - 1511mm, <p style="text-align: center;">Sash height</p> <ul style="list-style-type: none"> - max 2600mm, <p>Note: proportion of sash width to sash height - 1.5 Max sash weight 130kg - (tilt, tilt&turn). Max sash weight 50kg - (turn). Max sash weight 80kg - (triangle, rounded, arched)</p> <p>Weight of 1m² of glass (1mm thickness) - 2.5kg</p>	
6	GLAZING UNITS	<ul style="list-style-type: none"> - glazing unit thickness 34 - 54mm - rectangle, trapezium, triangle shapes - glazing unit thickness 36; 44; 48mm - rounded, arched shapes 	
7	TIMBER FINISH	Final painting with water-based opaque paints or stains	
8	COLOUR	<ul style="list-style-type: none"> - opaque: RAL 9016 (white), - Stain: Pine TM367, Afromozja TM4239, Mahogany TM1530, Palisander TM1705, Teak TM1703, Cyprys TM5207, Venge TM9012, Nut TM1515, Graphite TM1504, 	
9	DRIP CAPS	Frame thermally broken drip cap, additional sash drip cap (standard) <ul style="list-style-type: none"> - white, brown, olive - other colours from RAL palette at request, 	
10	COVERS	fittings: hinge covers: white, olive	
11	GLAZING BARS	<ul style="list-style-type: none"> - construction (structural) bars 80mm, - vienna (glued-on) bars 12x24mm, - internal glazing bars (inside insulated glass unit), 	

	<i>technical issue</i>	<i>description</i>	<i>notes</i>
12	Widths of construction elements	<ul style="list-style-type: none"> - Sash element width: 80-110mm, - Frame element width: 83-114mm, 	
13	VENTS	<p>in sash:</p> <ul style="list-style-type: none"> a) Aereco EMM b) Trimvent 90 HL c) Aereco EXR <p>Note: External vent hood fitted on frame head.</p> <p>in frame:</p> <ul style="list-style-type: none"> a) Trimvent S13 b) Aereco EMM c) Ventair 	
14	ADDITIONAL OPTIONS	<ul style="list-style-type: none"> - frame widener, - frame connector, - 90 degree corner post, - 135 degree corner post, - counterprofile, - thresholds, <ul style="list-style-type: none"> a) Cutting 12x30 mm from outside and cutting 11x30mm from inside, b) Cutting 11x30mm from inside, c) Cutting 12x30 mm from outside, d) Cutting 12x30 mm from outside and cutting 11x14mm from inside, e) Cutting 12x30 mm from outside and groove 10x10mm from inside, f) without cutting, - timber cover bead (45mm, 35mm), 	
15	SILICONE	<ul style="list-style-type: none"> - transparent, 	

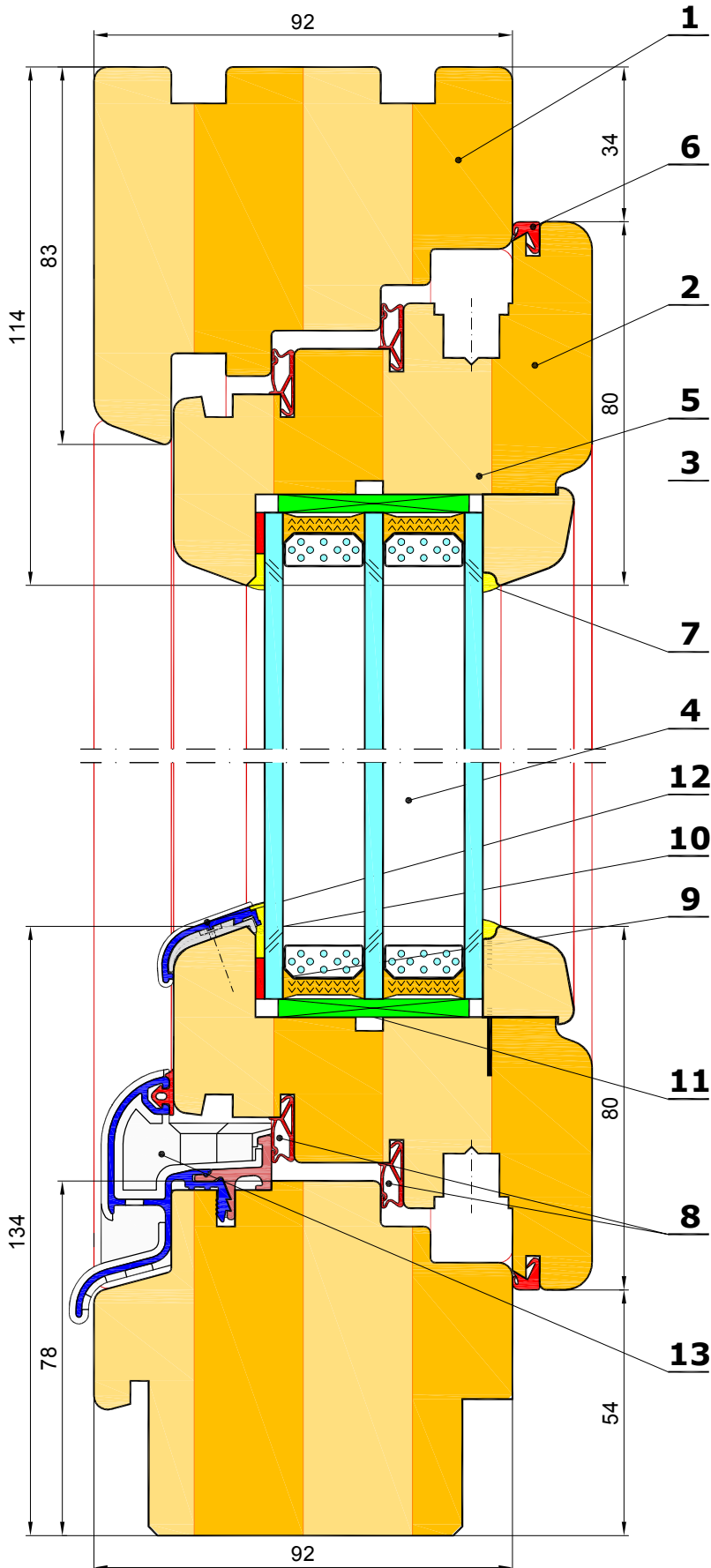

Elements

- 1 - window frame - timber
- 2 - window sash - timber
- 3 - glazing bead with groove for silicone
- 4 - insulated glass unit
- 5 - steel nail SK330 (1,1x30mm)
- 6 - edge gasket TPS - SP33 Deventer
- 7 - silicone according to DIN 1845 T.2 (group E)
- 8 - rebate gasket - SV103 Deventer
- 9 - neoprene glazing gasket
- 10 - silicone according to DIN 1845 T.2 (group E)
- 11 - glazing PVC block - 3,5x25x100mm
- 12 - aluminium sash drip cap - LPRS 22 Z
set - drip cap LPRS 22 Z
- end cap right and left LPRS S/Z
- clip LPRS 22 Z
- 13 - aluminium gutter drip with
thermal insert- Effector
set - aluminium gutter drip
- drip plugs: right and left

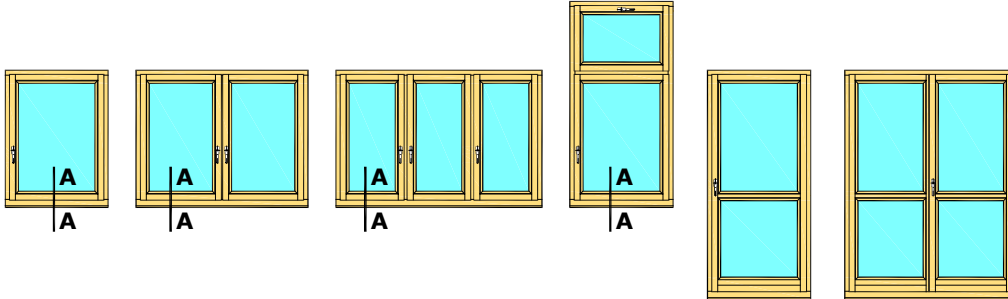

A-A

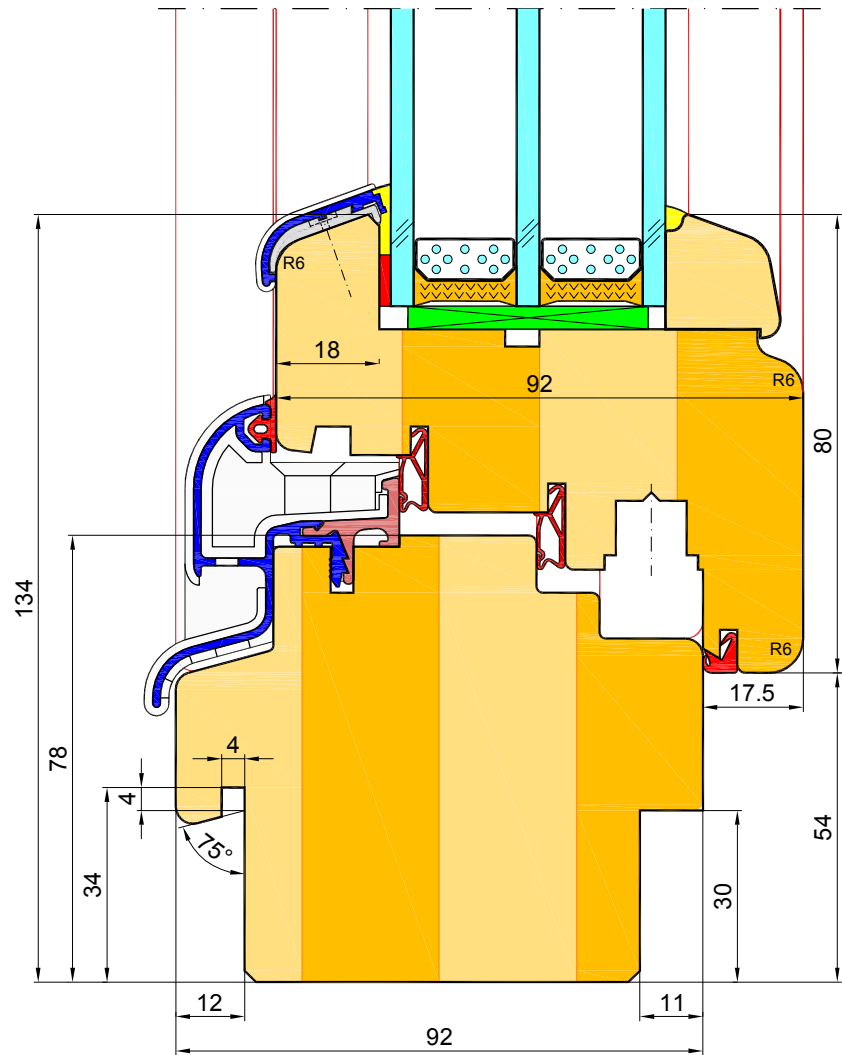

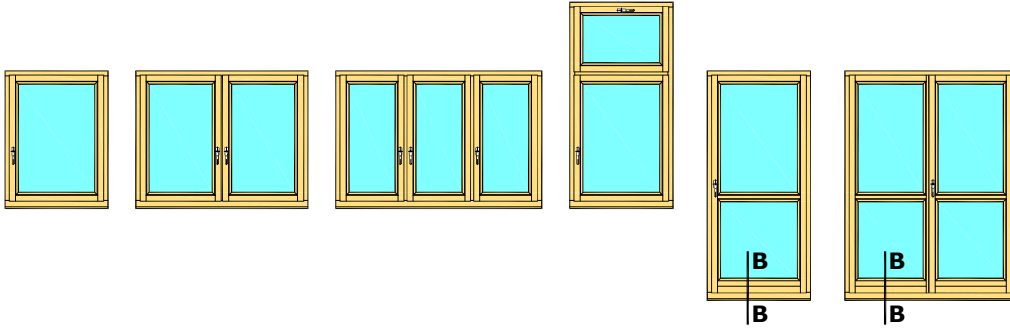

B-B

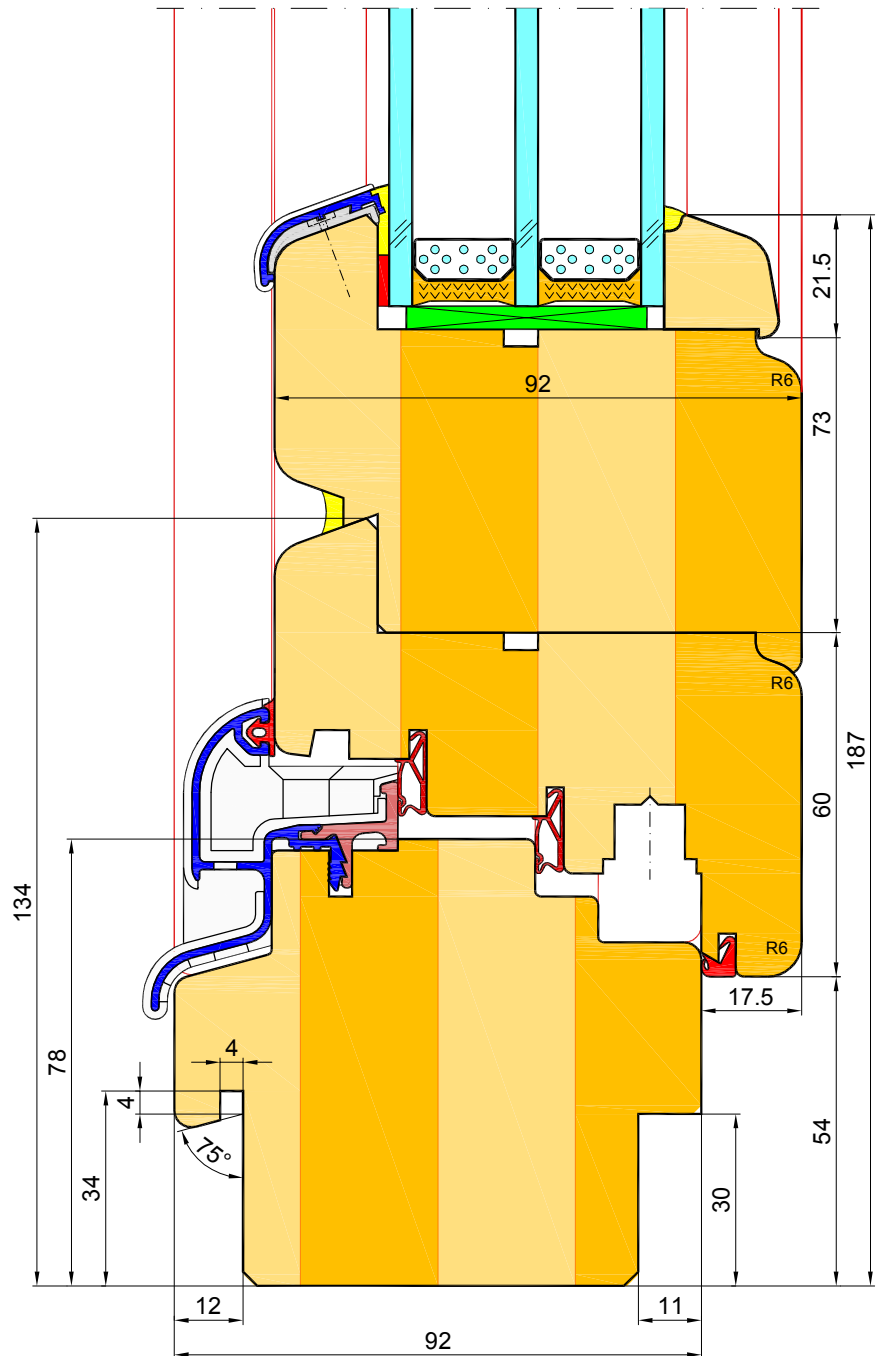

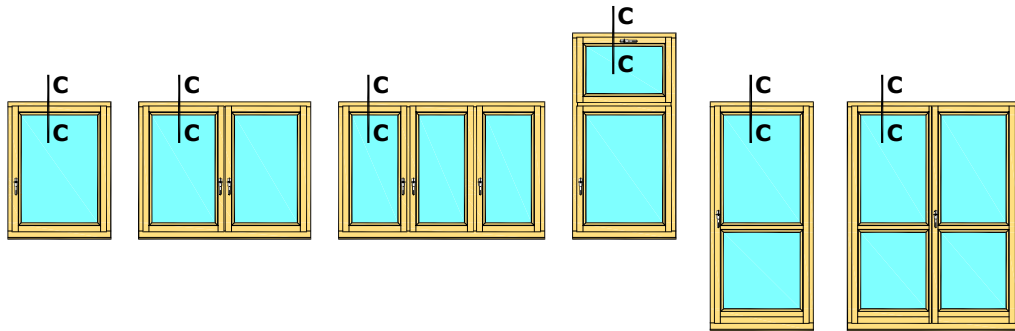

C-C

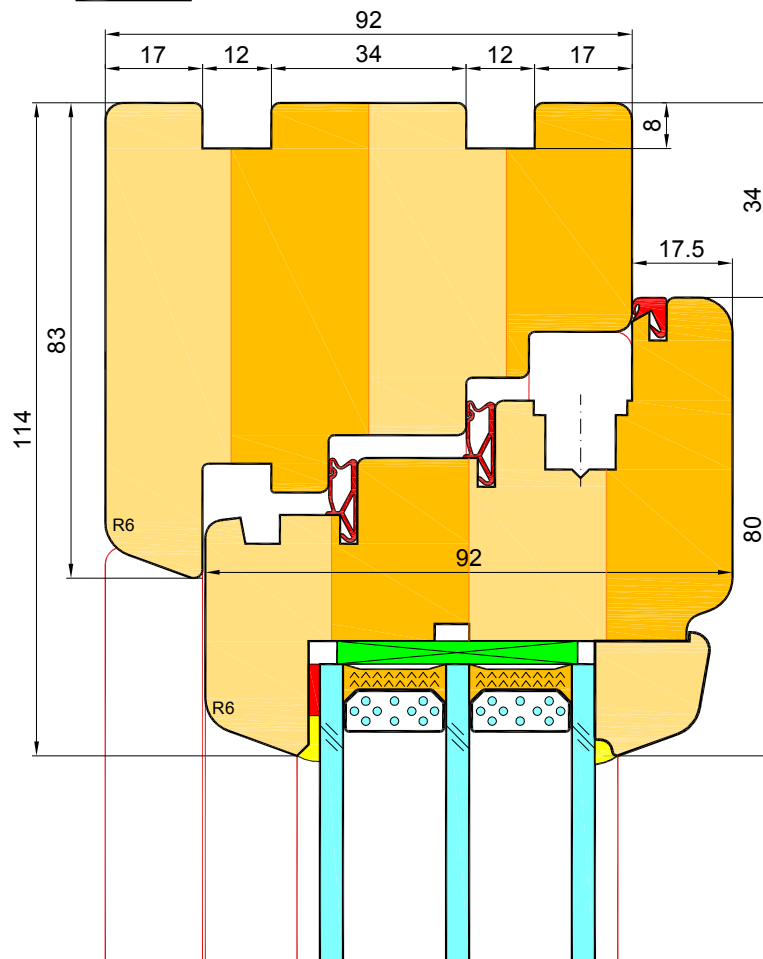

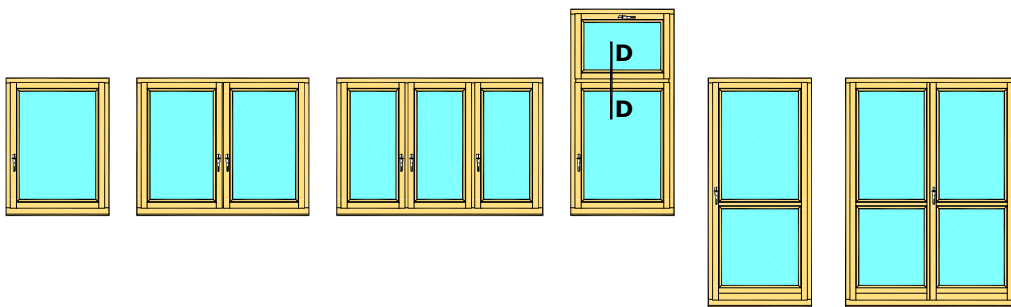

D-D

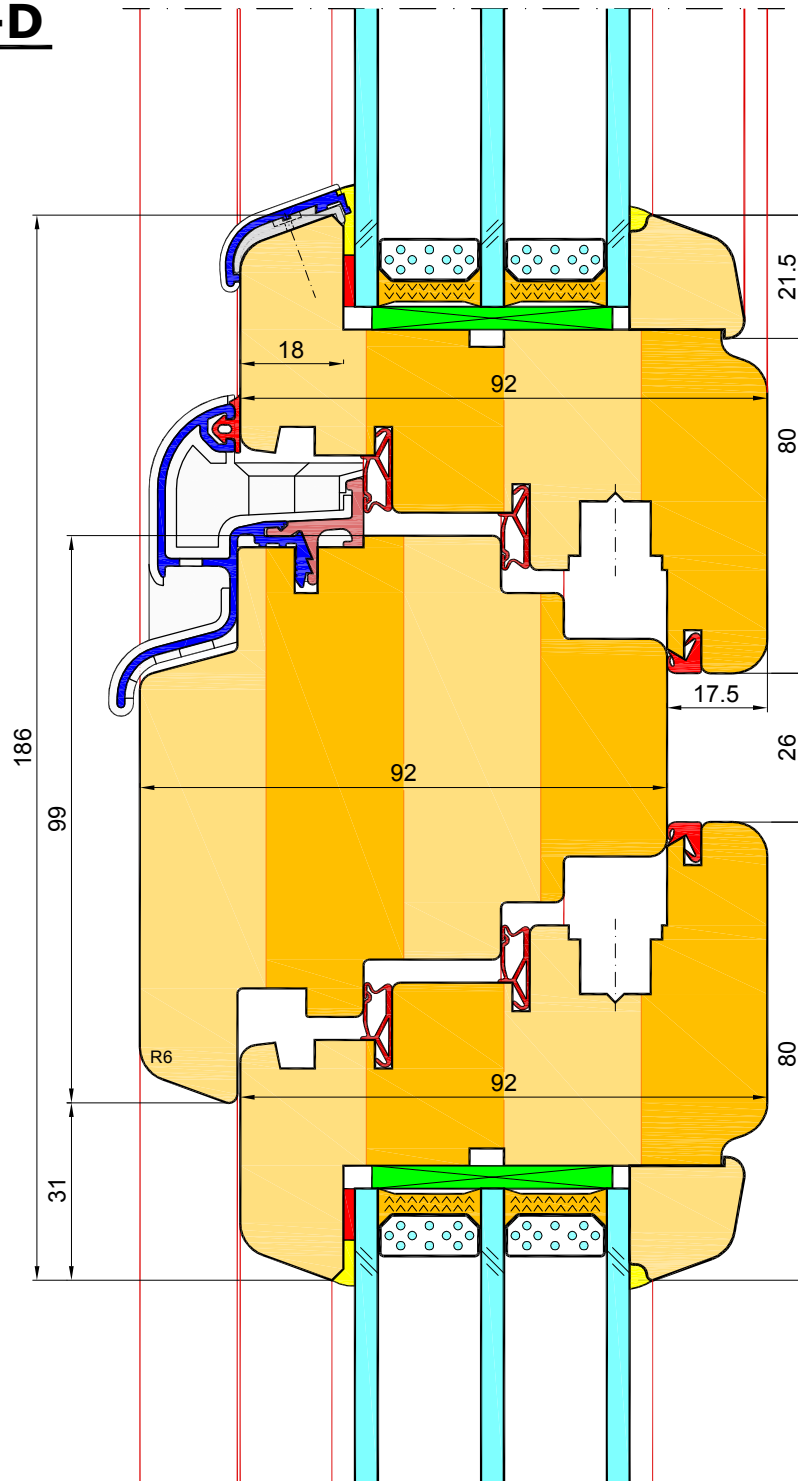

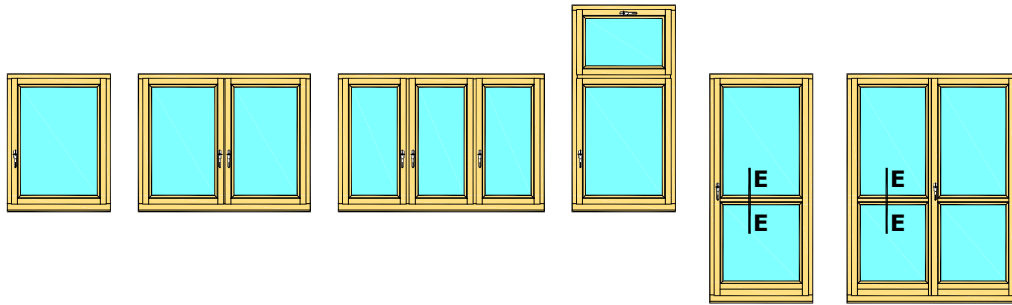

E-E

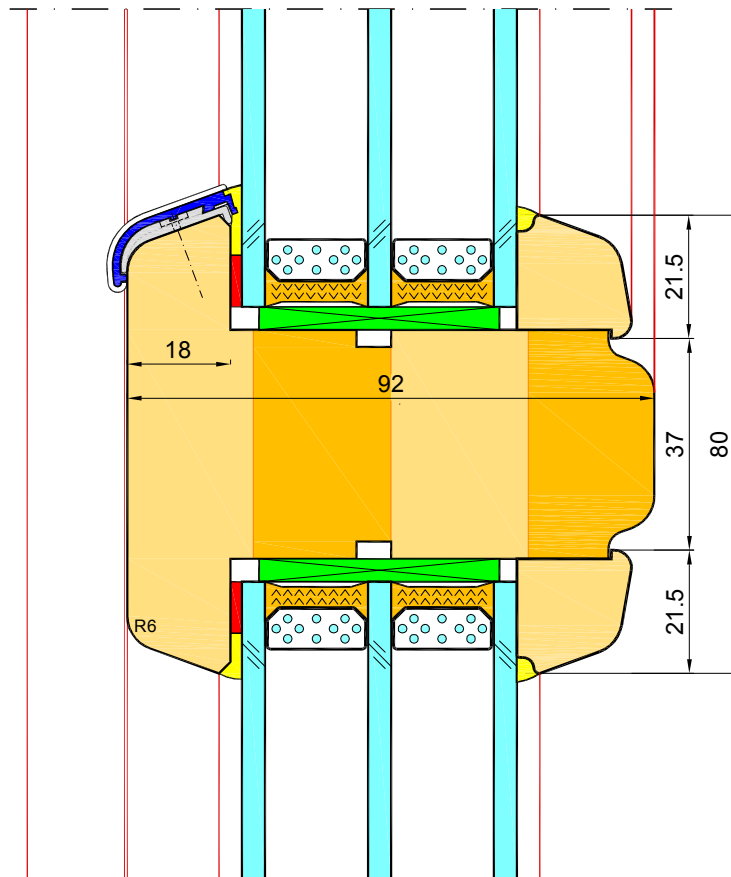

sash construction bar 80mm

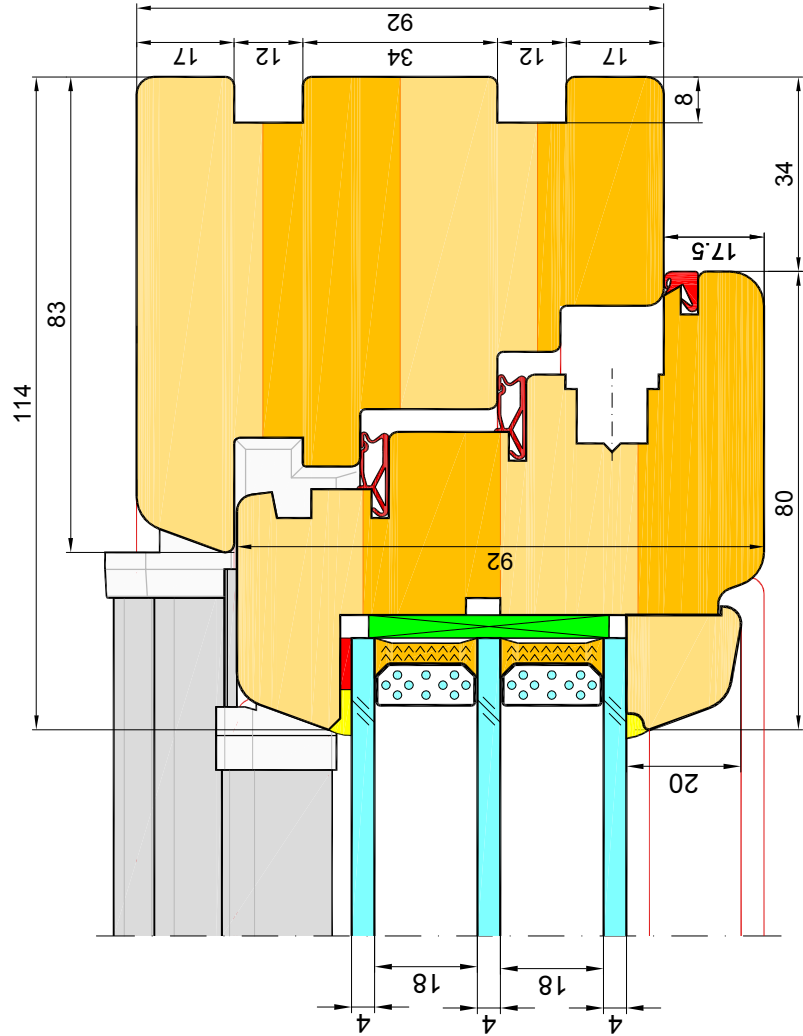
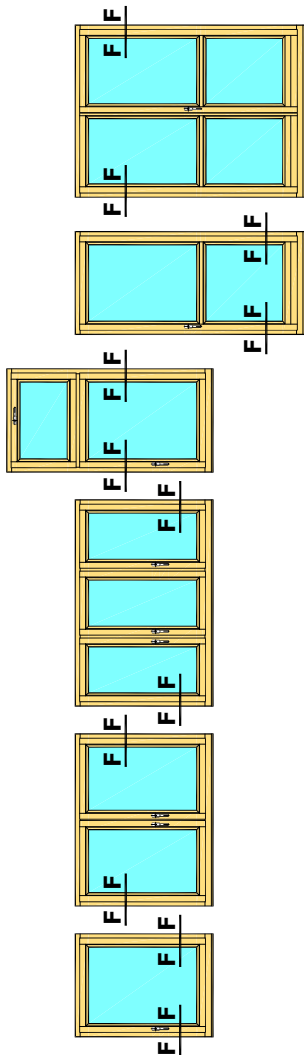

F-F

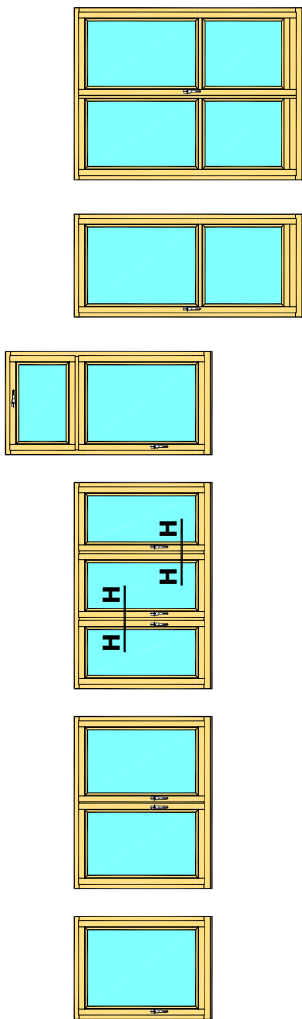

H-H

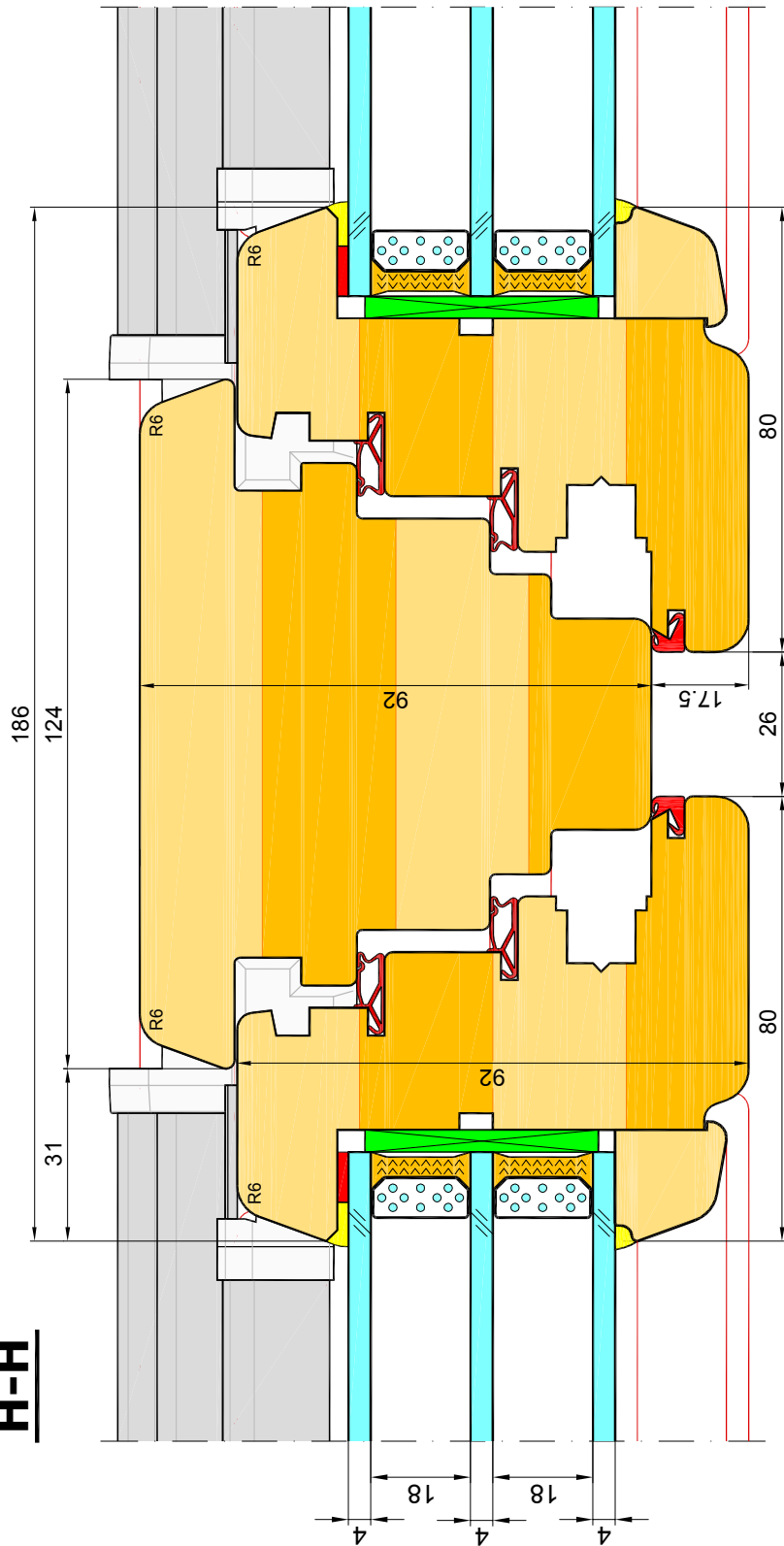

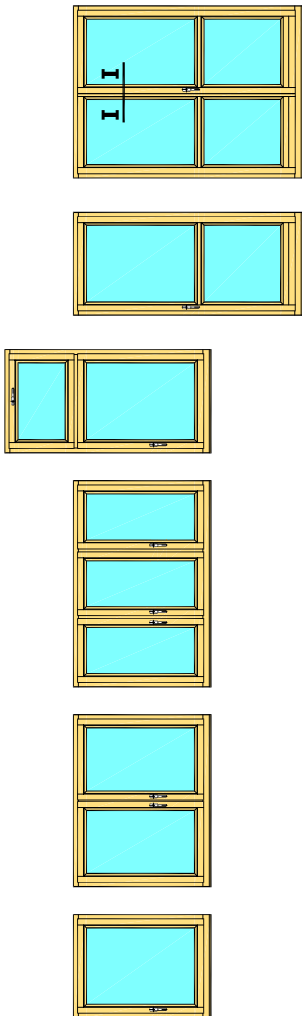

I-I

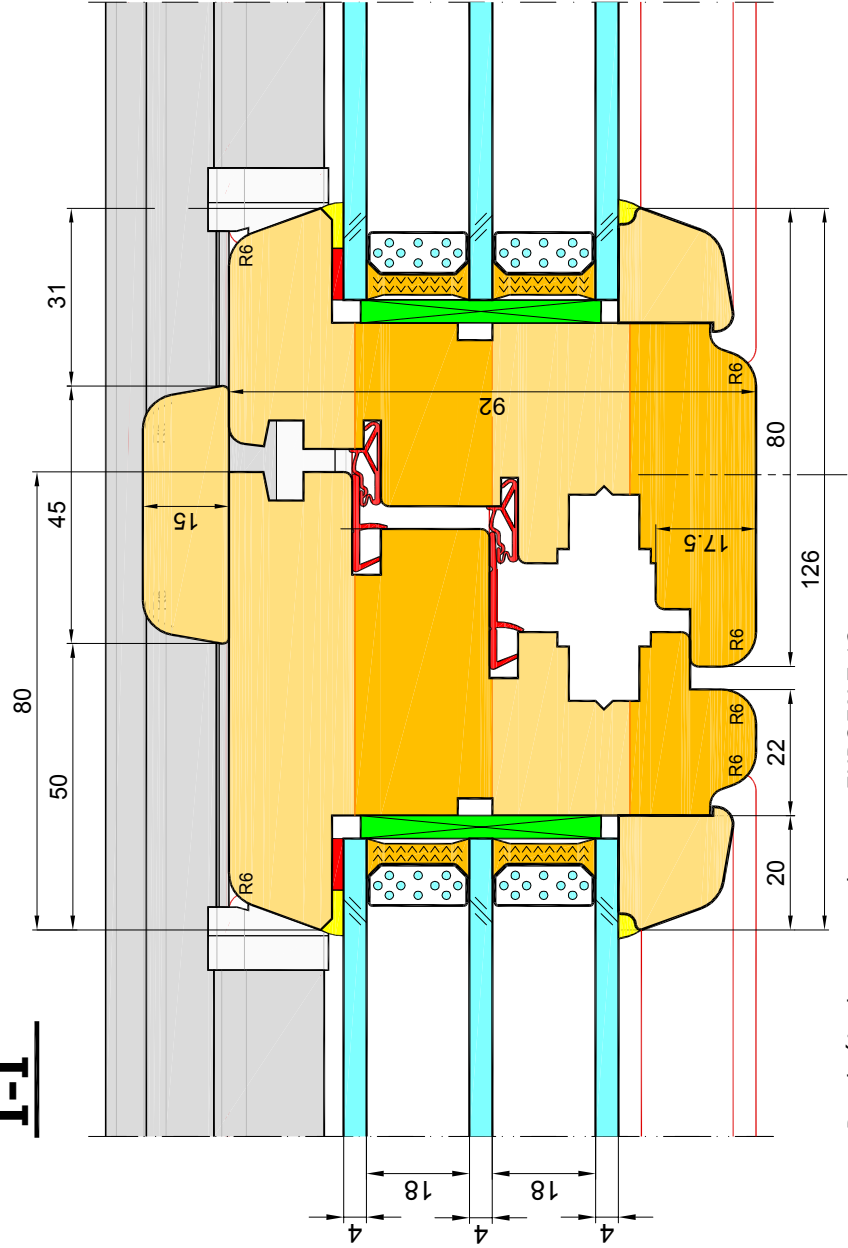

Przekrój z luzem wrębowym EUROFALZ 12mm.

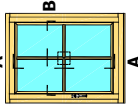
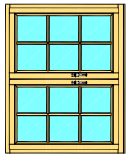
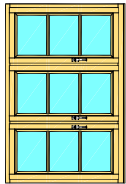
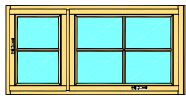
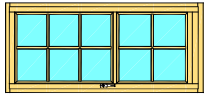
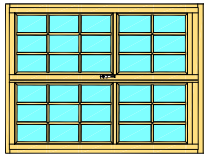
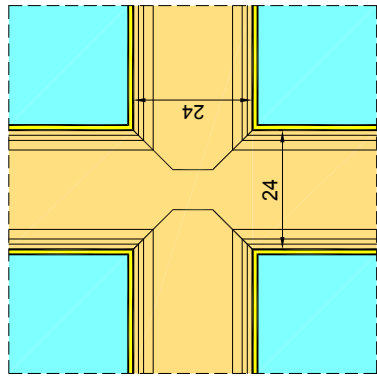

- Elements
- 1 - window sash
 - 2 - glazing unit
 - 3 - exterior timber glazing bar
 - 4 - internal glazing bar (inside glazing unit)
 - 5 - double sided adhesive tape
 - 6 - interior timber glazing bar
 - 7 - glazing bead with groove for silicone
 - 8 - silicone

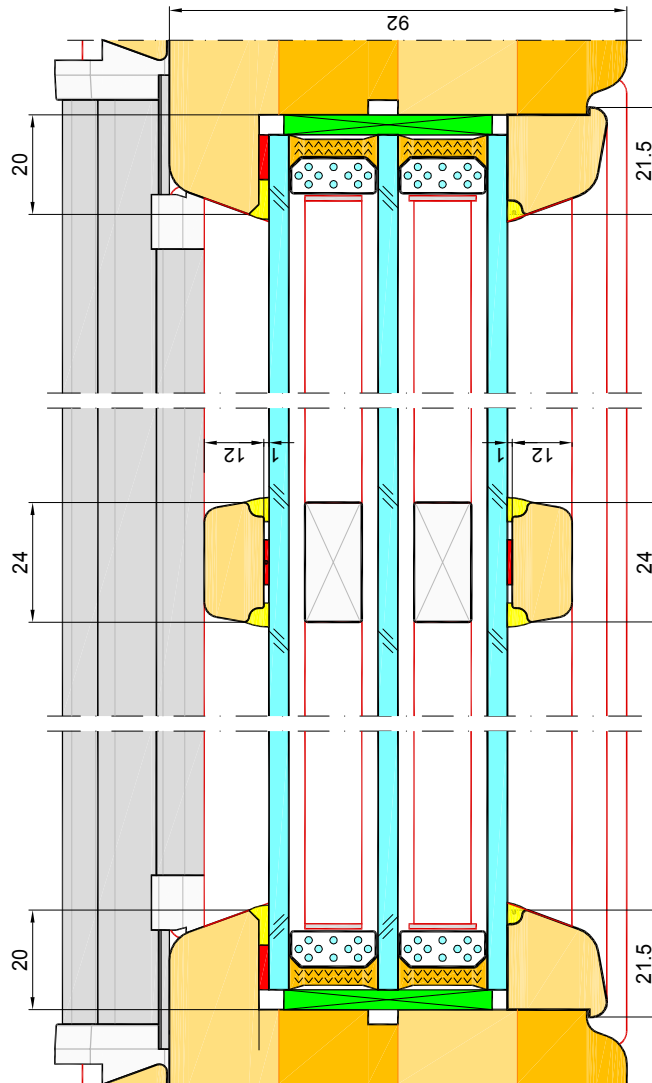
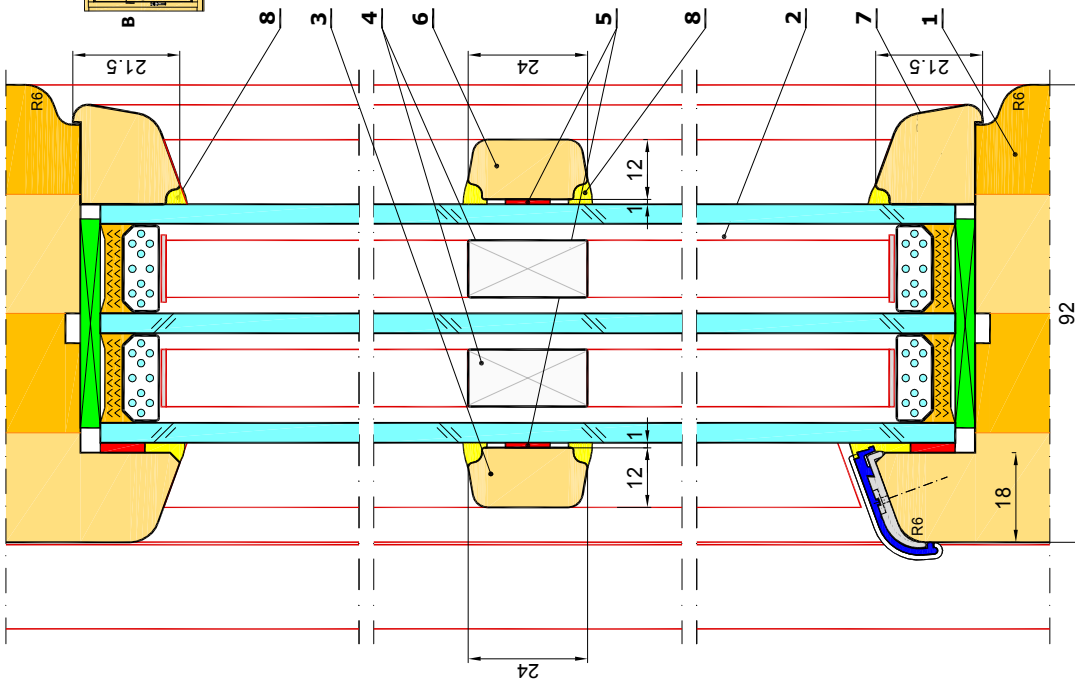

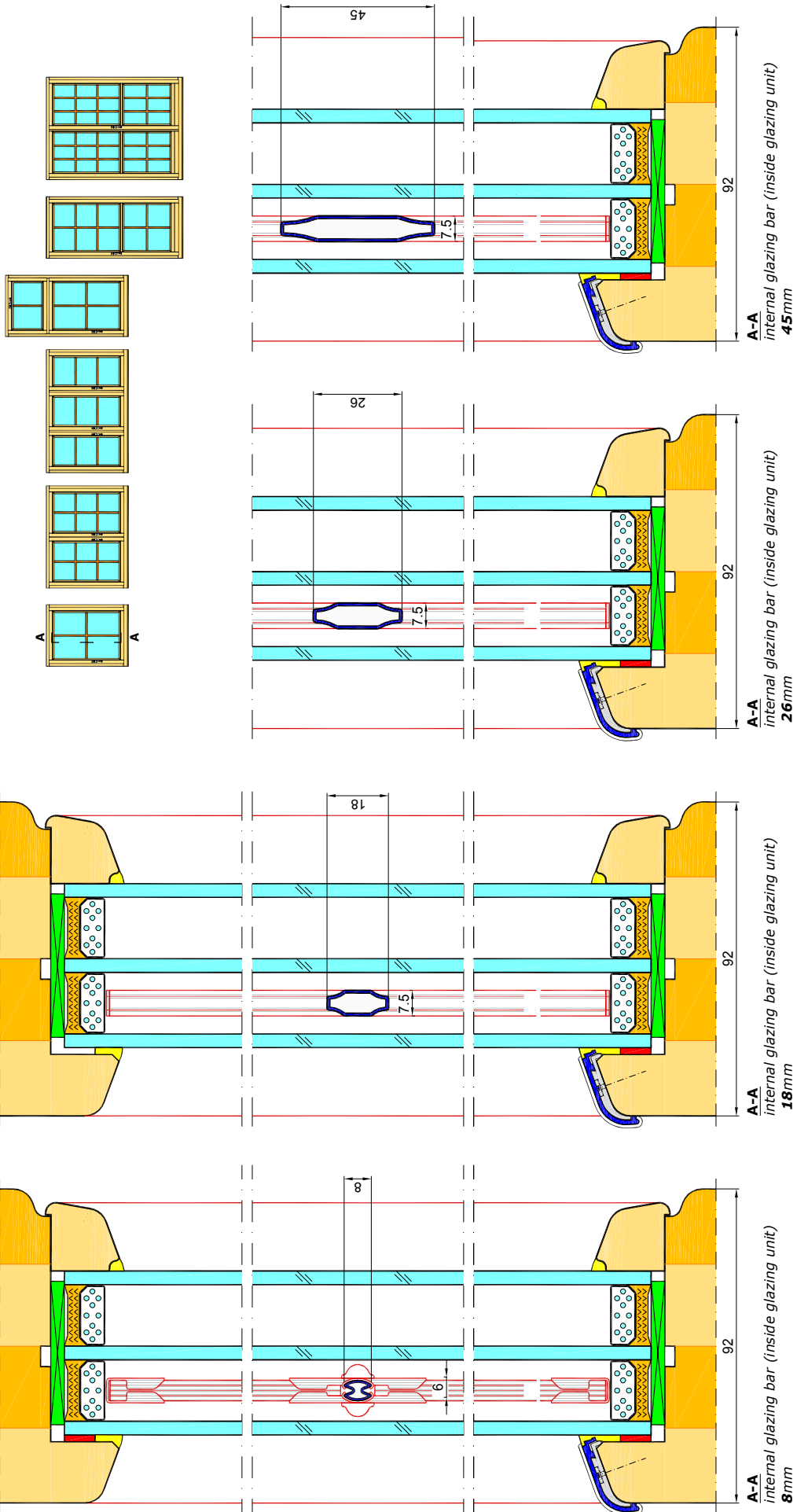

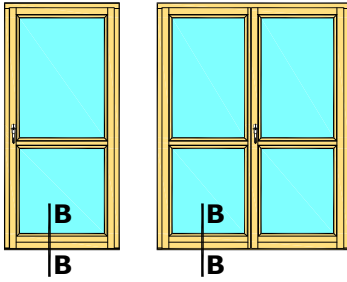

B-B

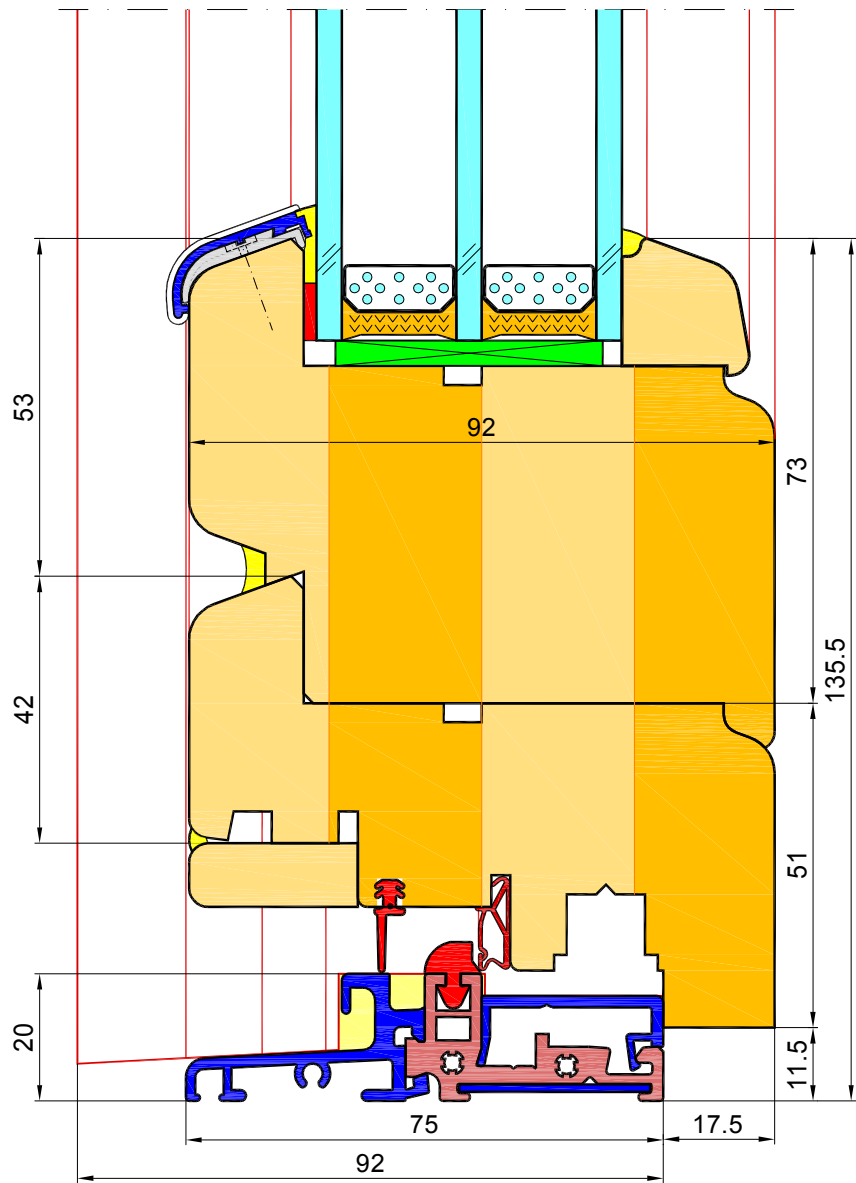

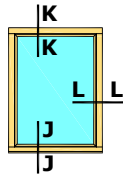

K-K

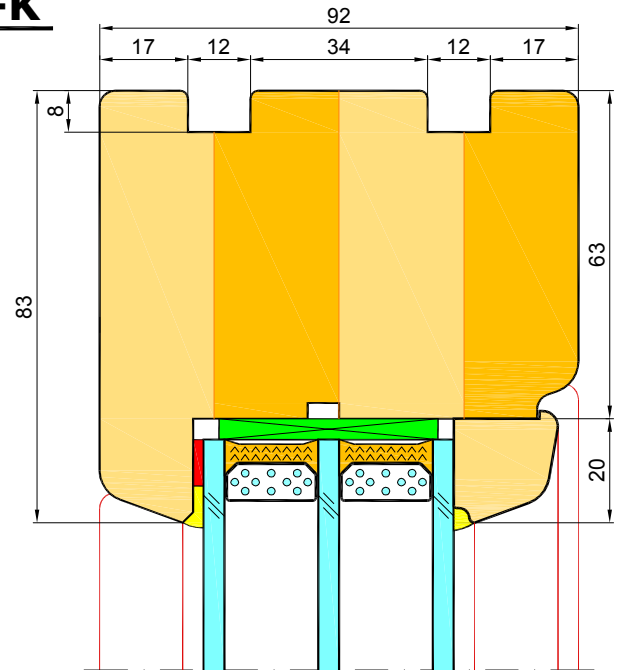

L-L

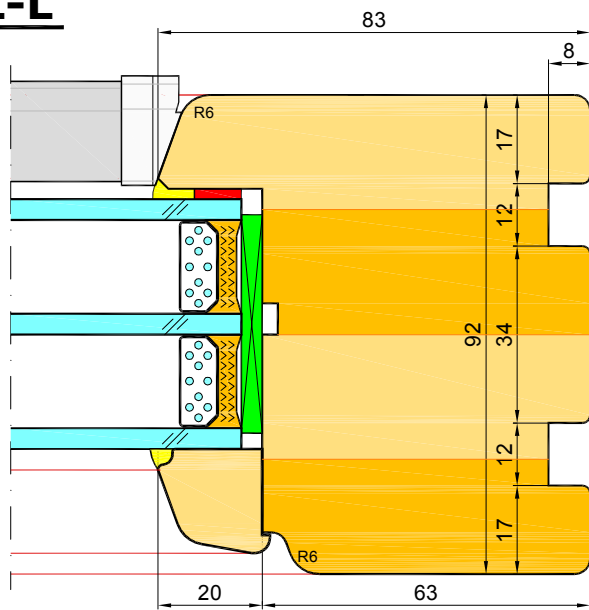

J-J

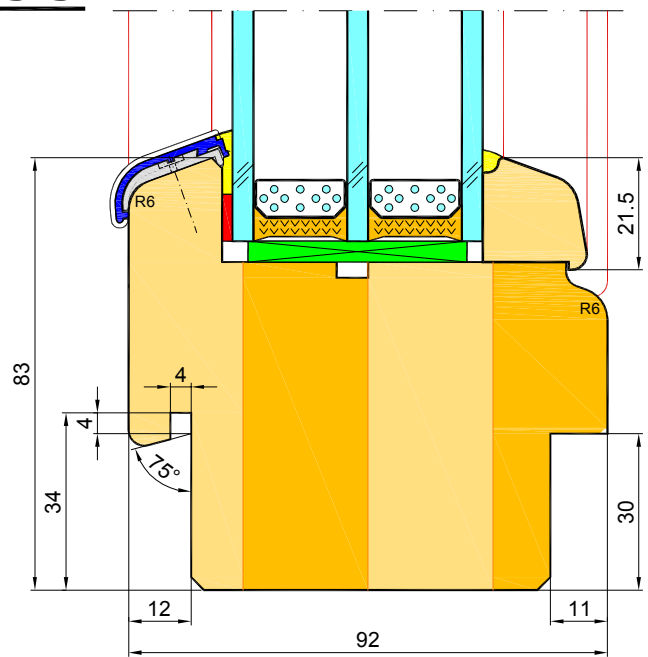

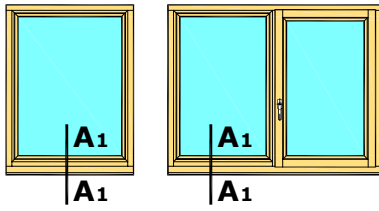

A1-A1

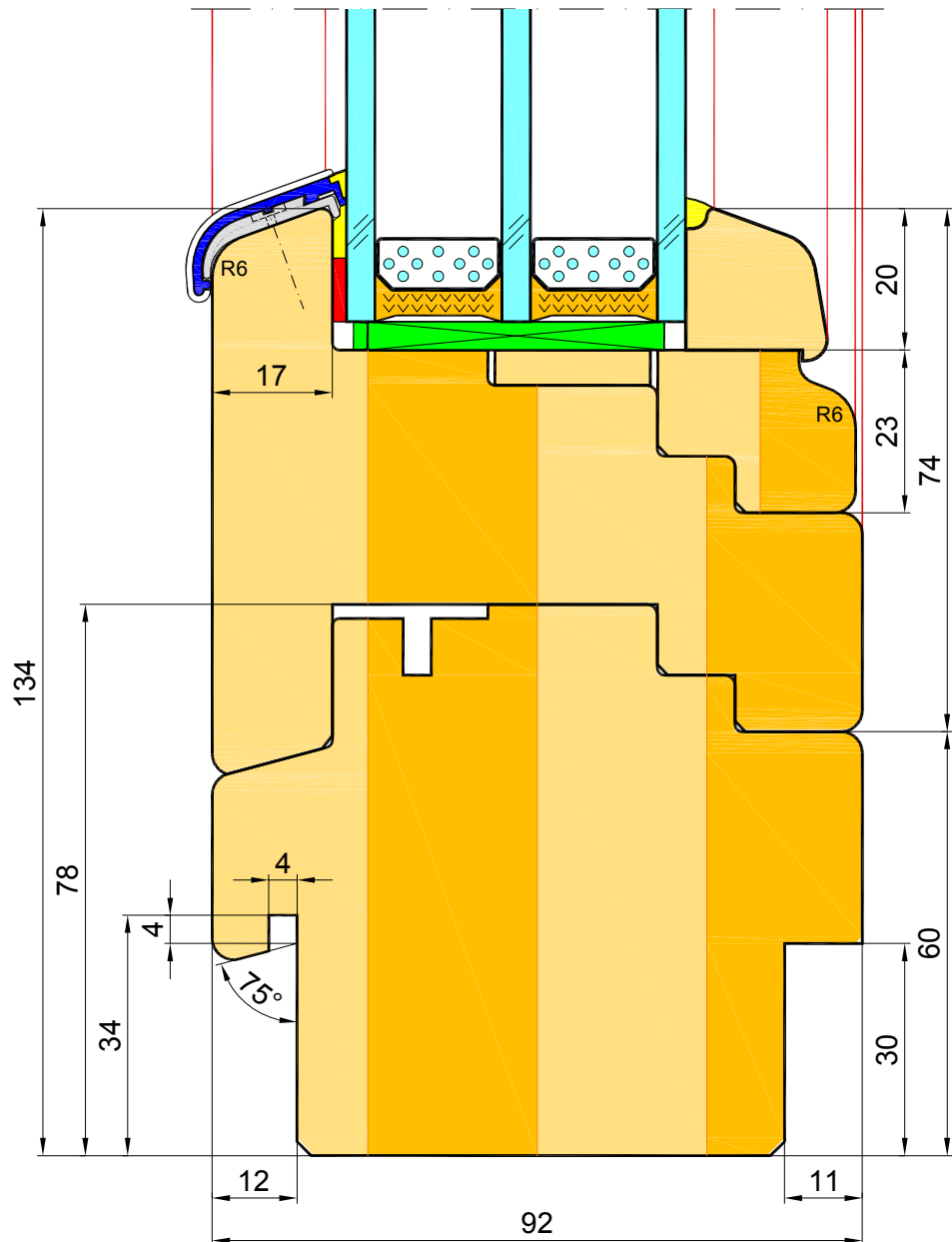

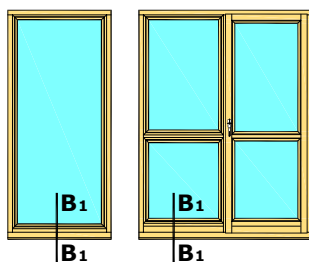

B1-B1

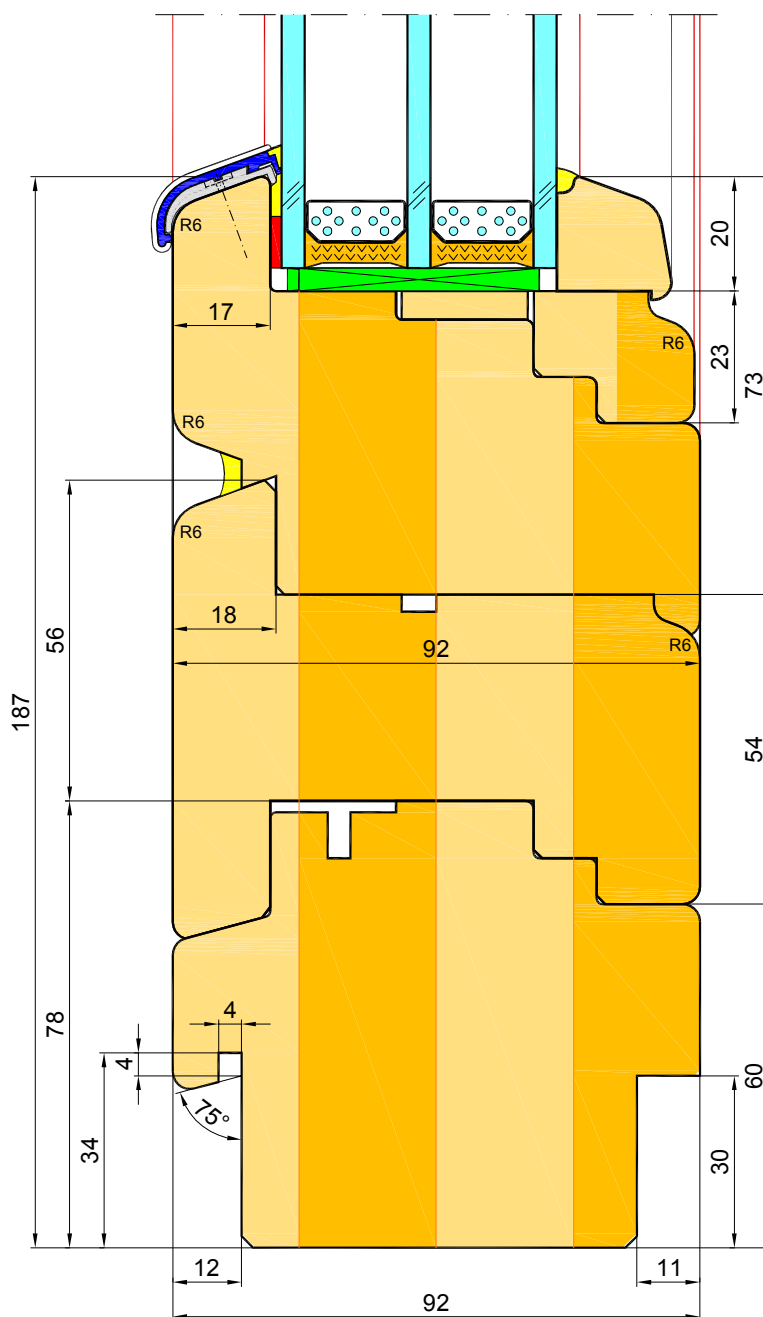

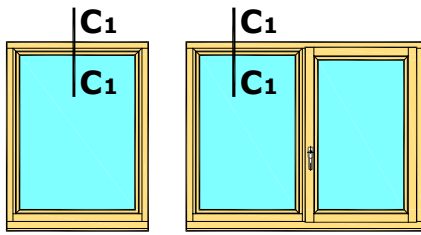

C1-C1

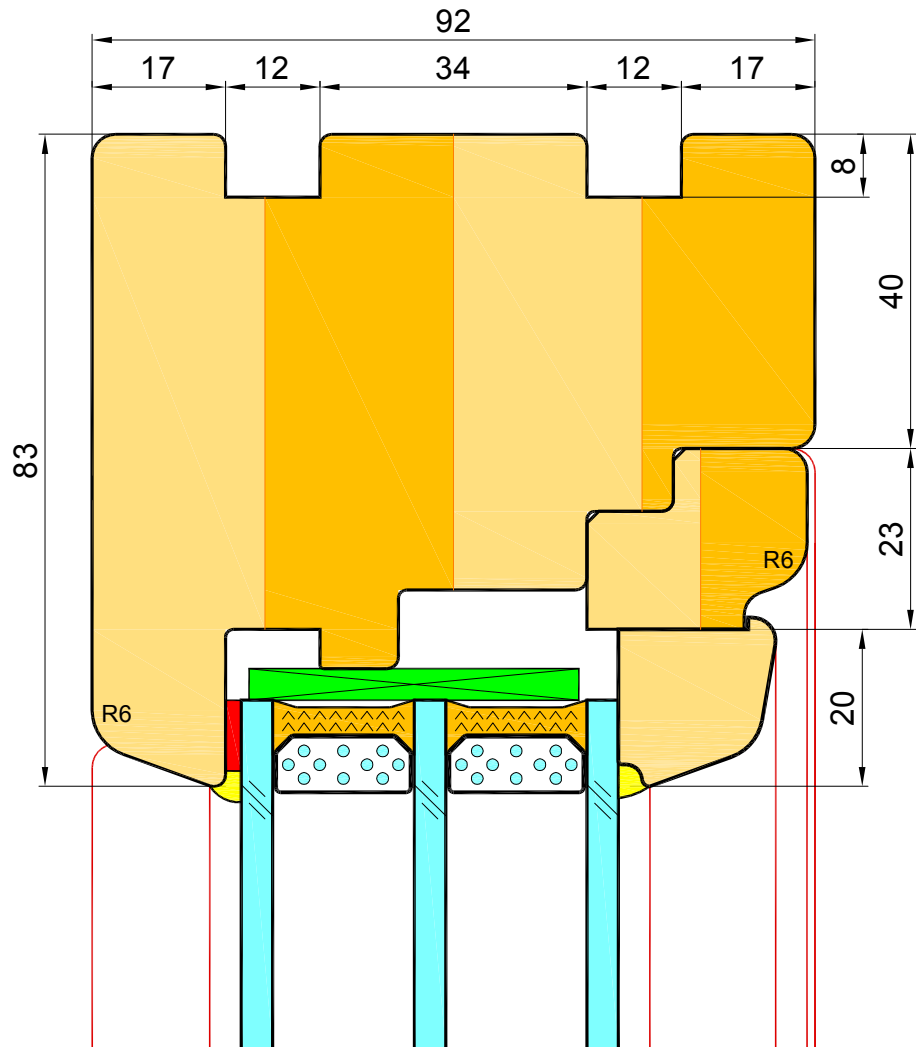

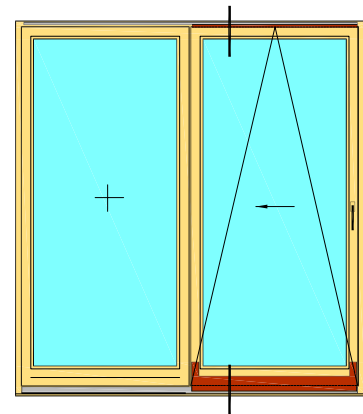
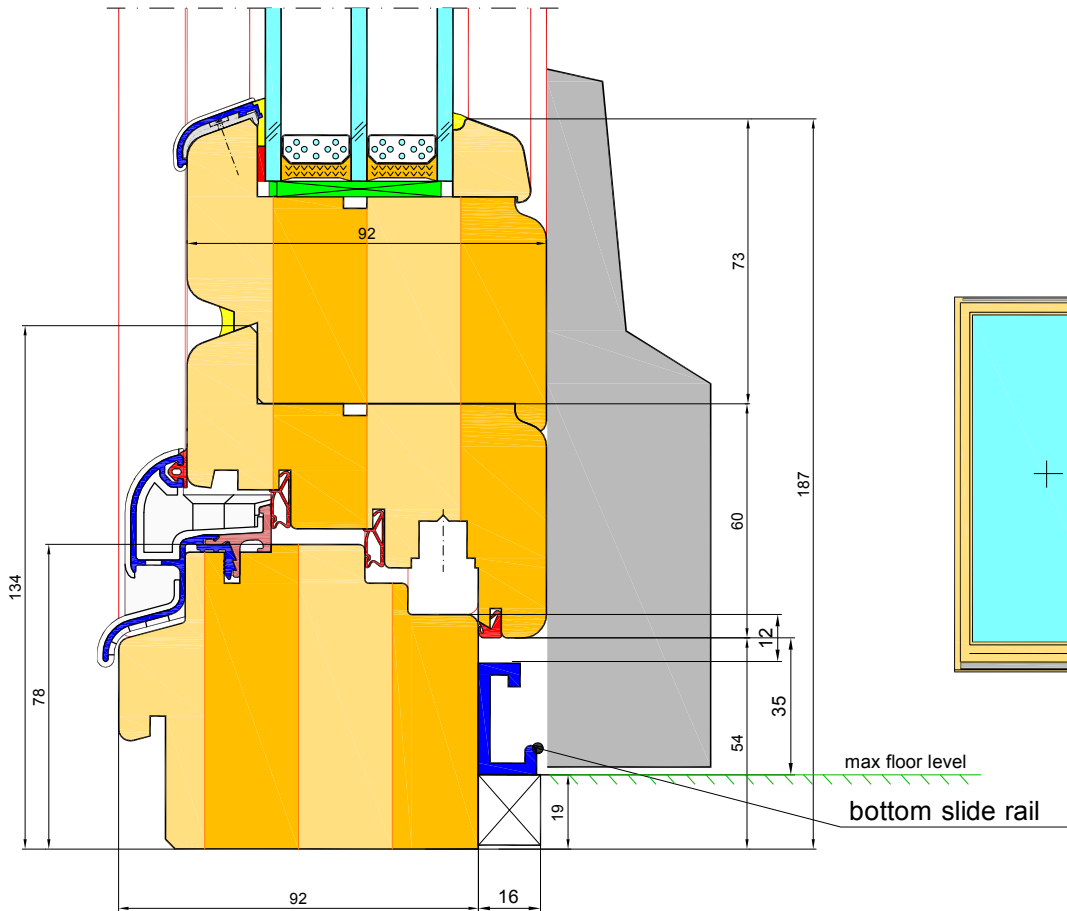
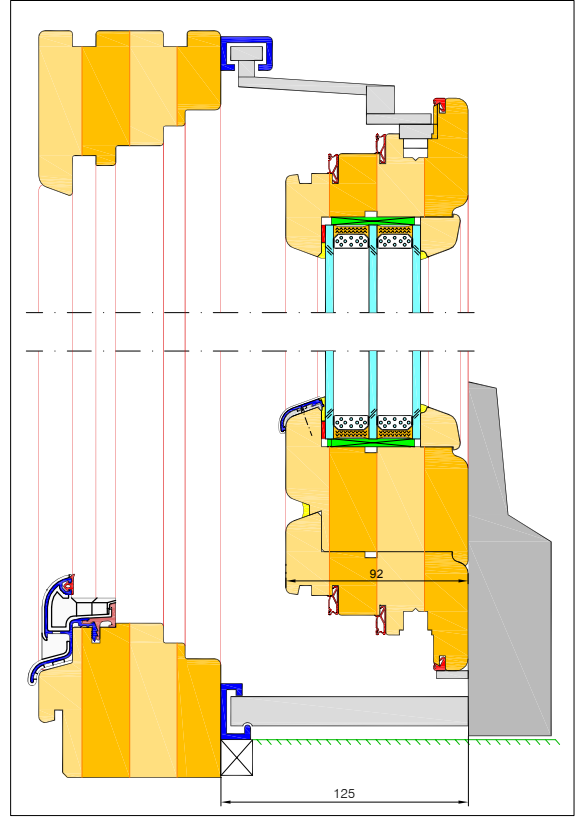
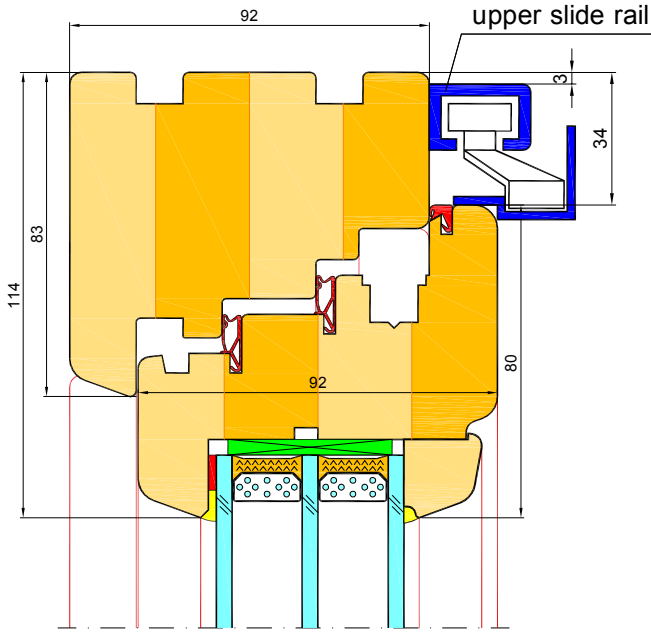

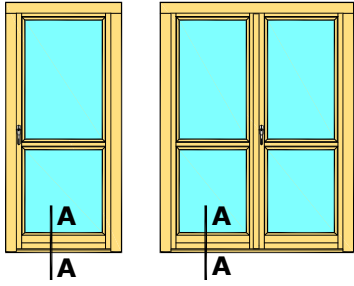

view from the inside

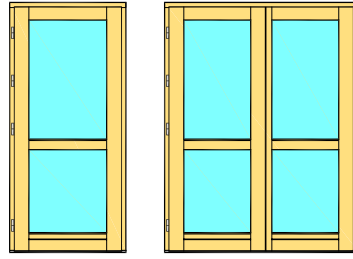

view from the outside

A-A

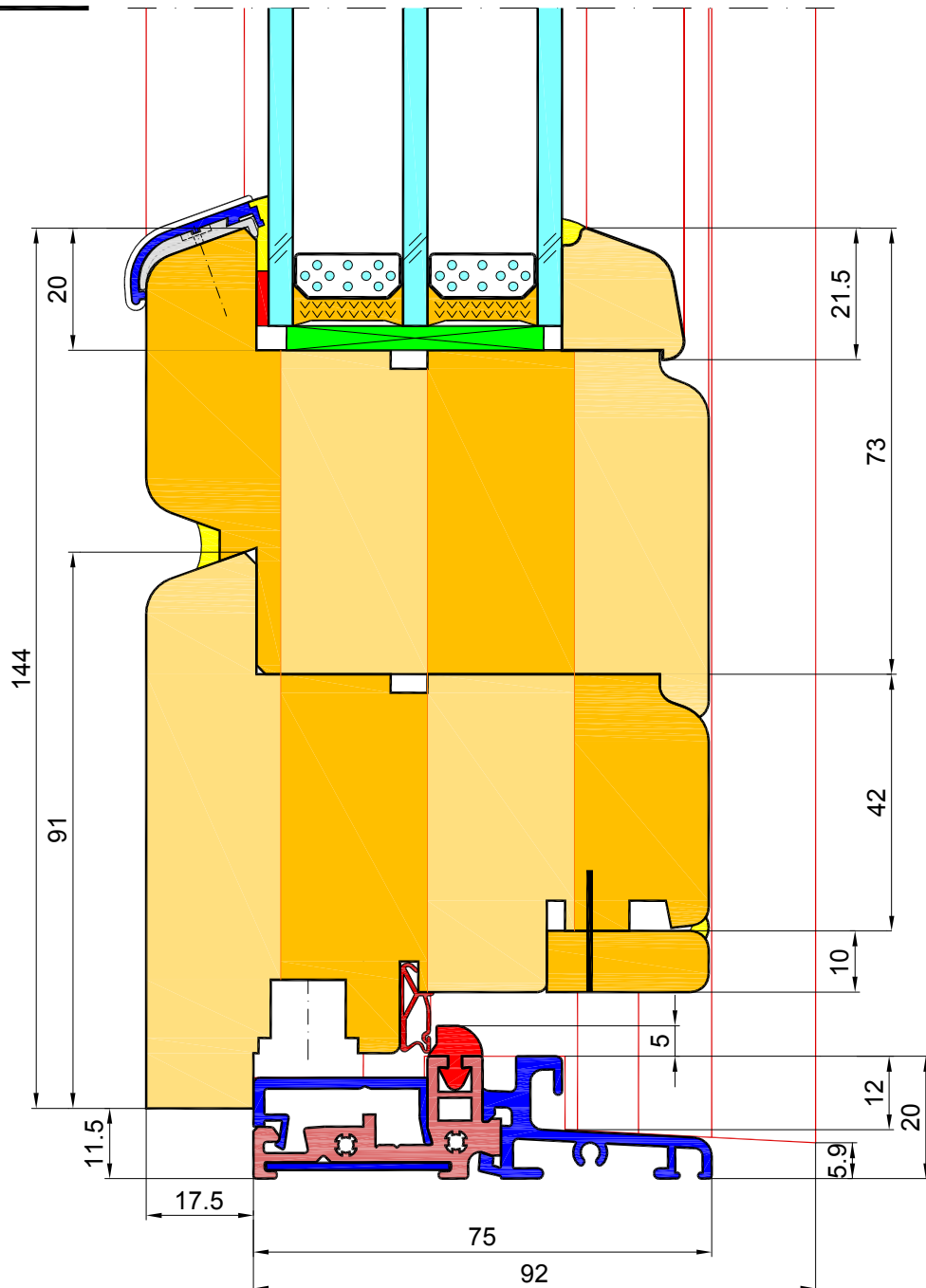

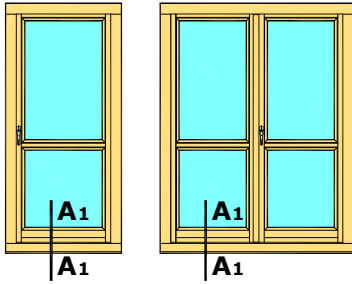

view from the inside

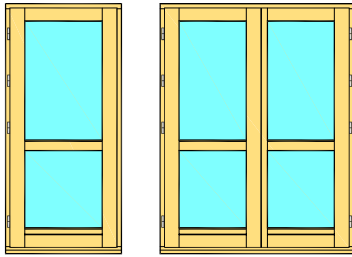

view from the outside

A1-A1

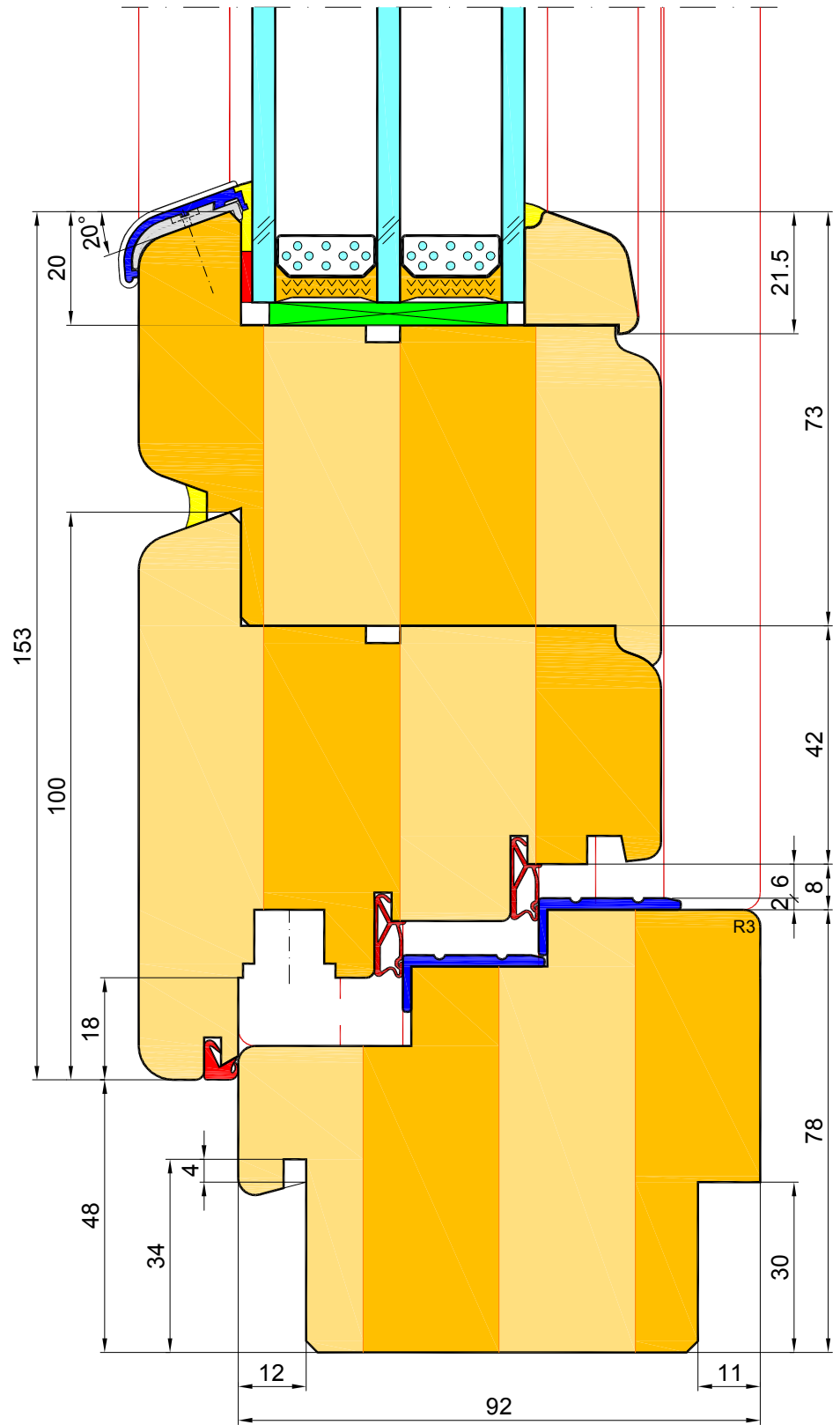

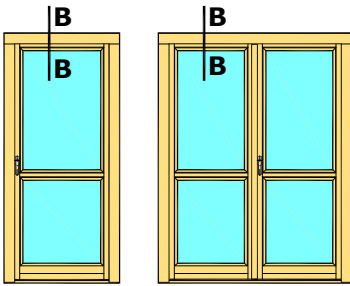

view from the inside

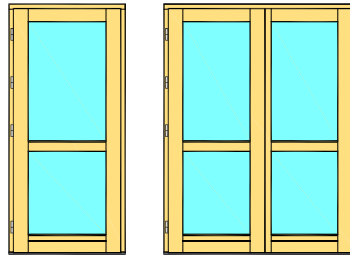

view from the outside

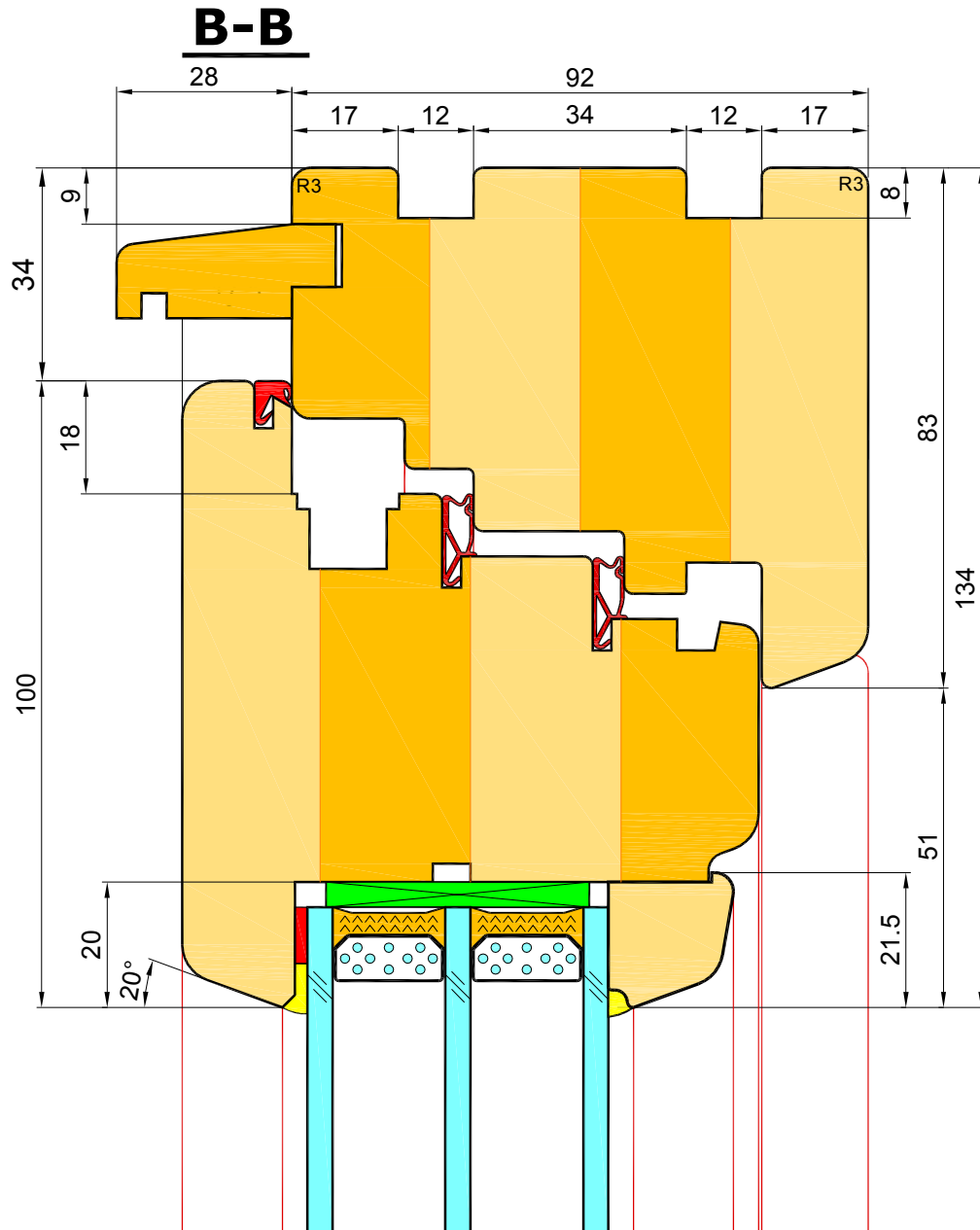

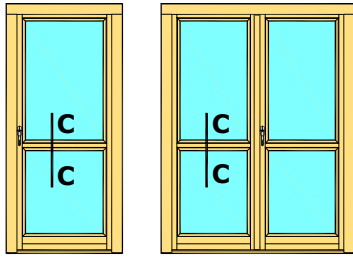

view from the inside

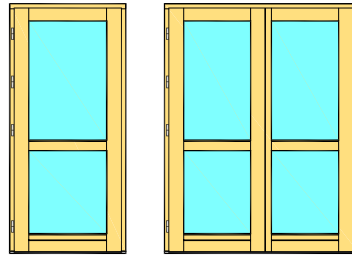

view from the outside

C-C

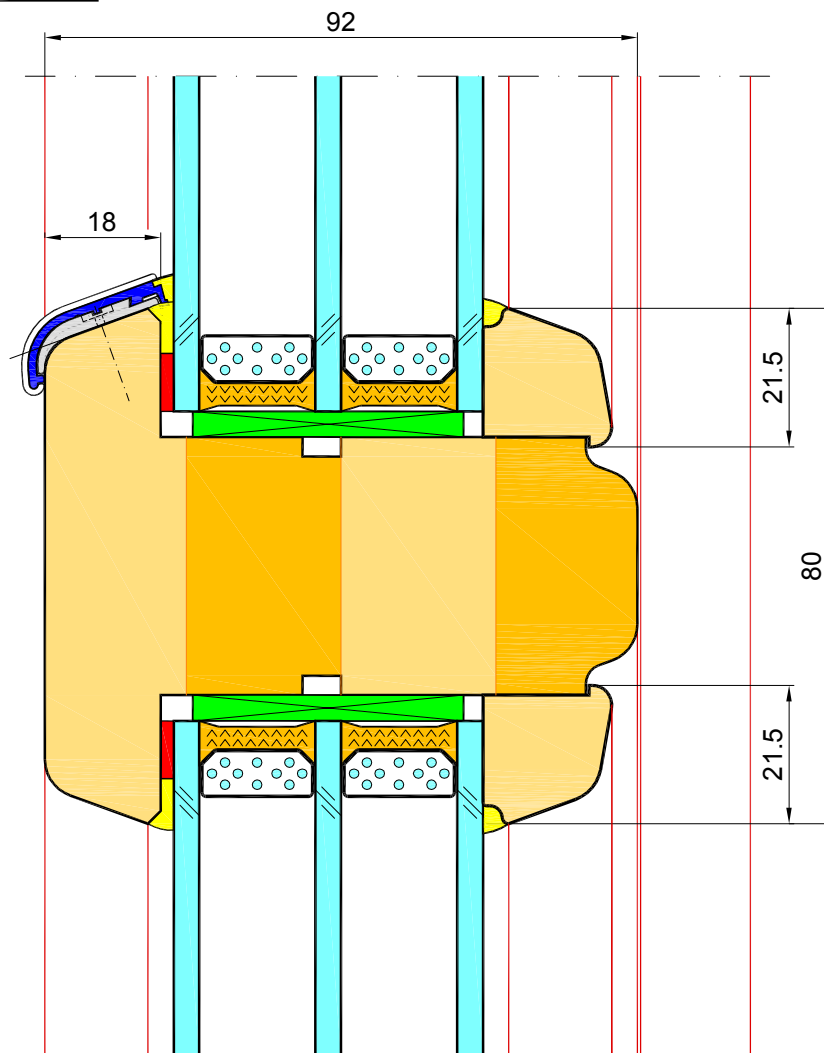

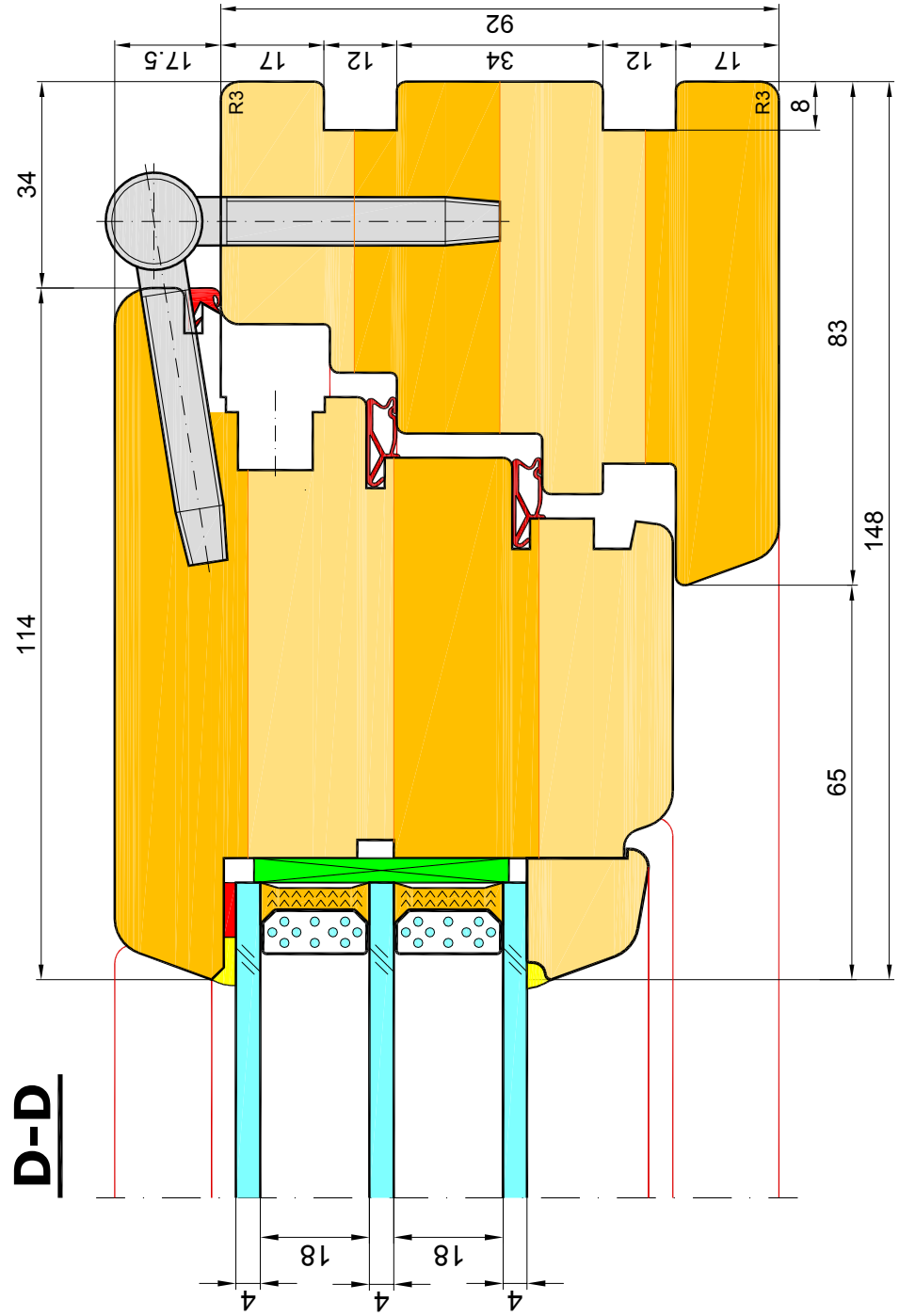

D-D

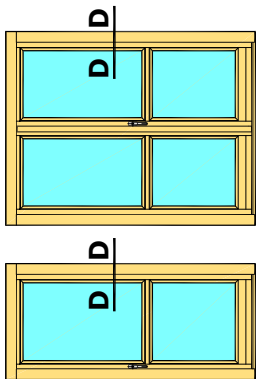

view from the inside

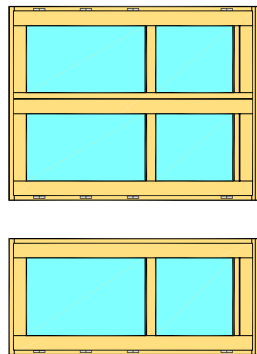

view from the outside

E-E

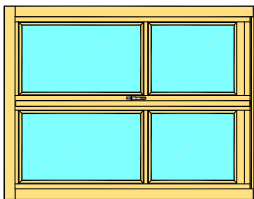
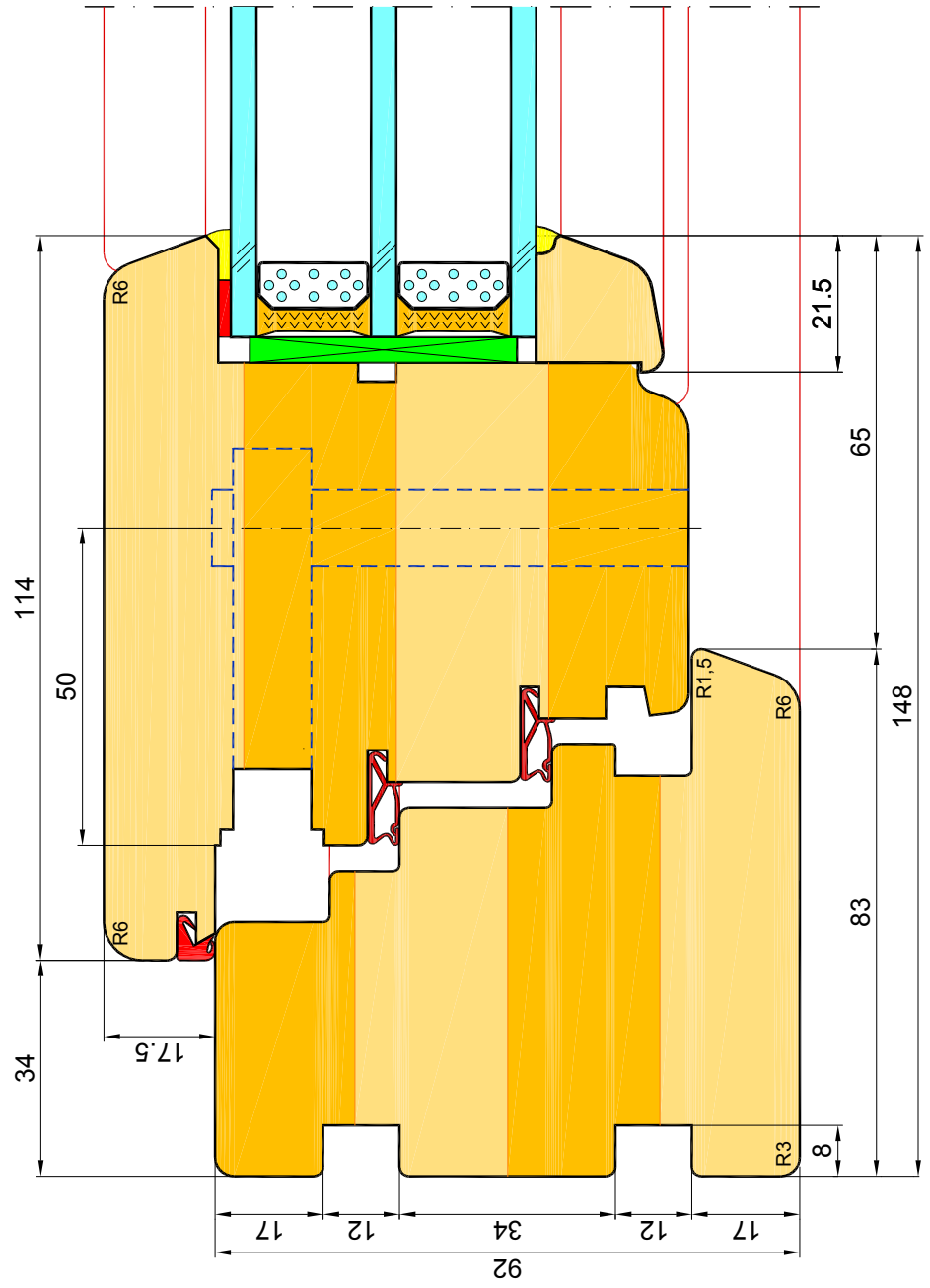

view from the inside

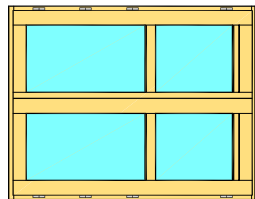

view from the outside

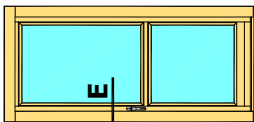

E-E

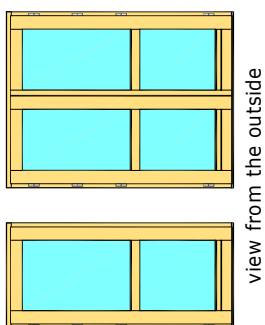
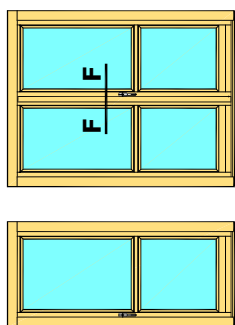
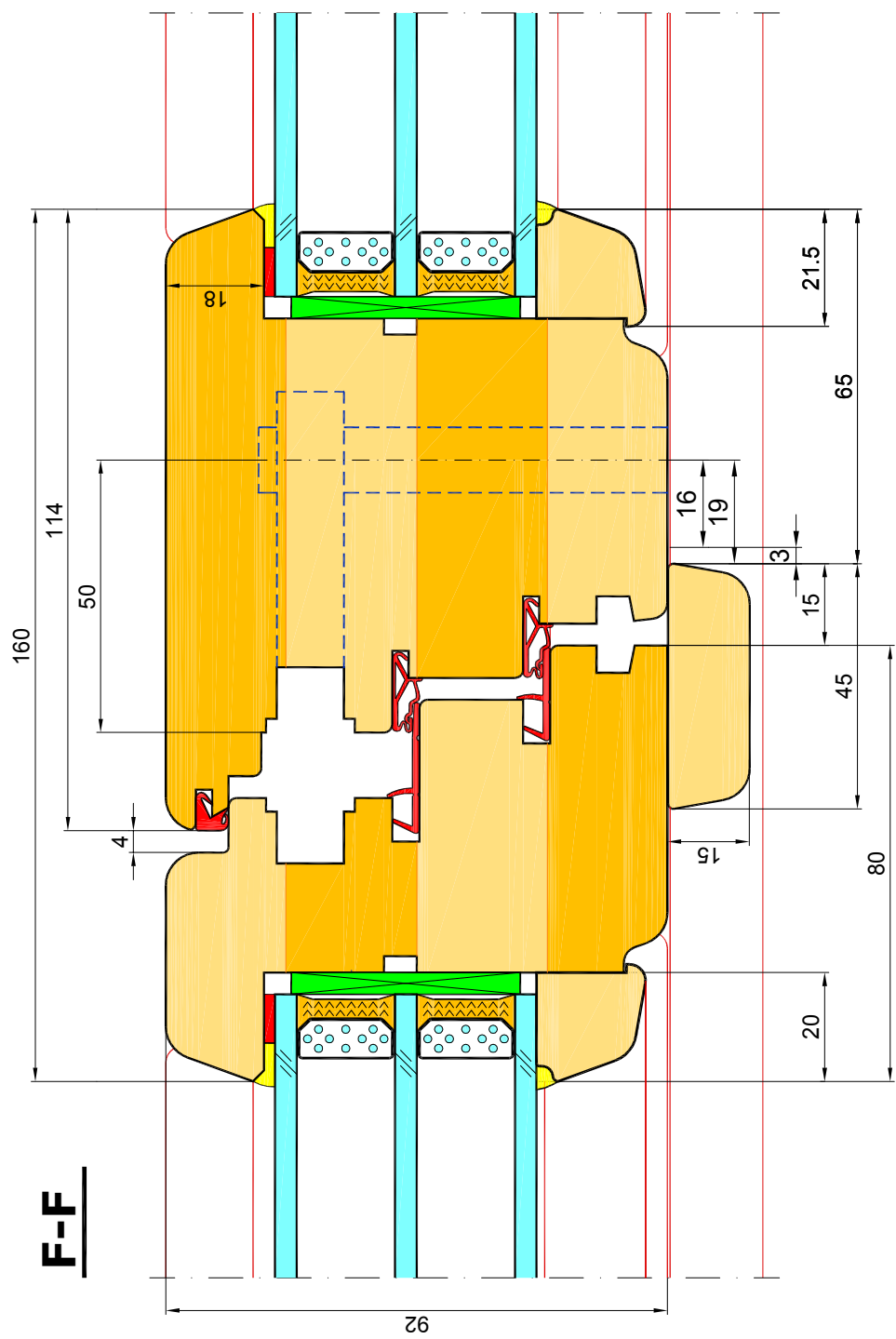

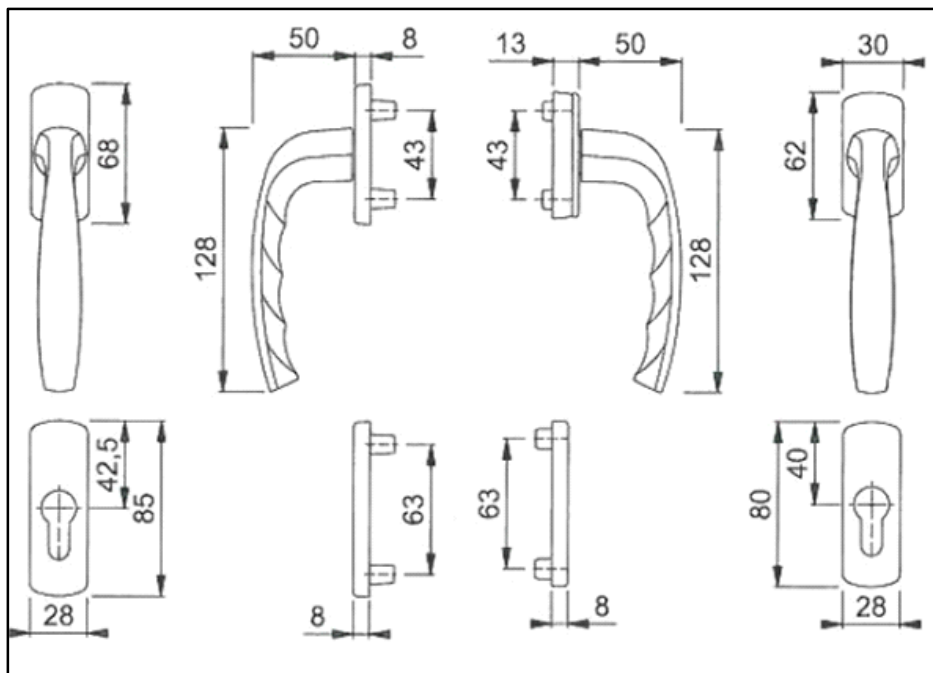
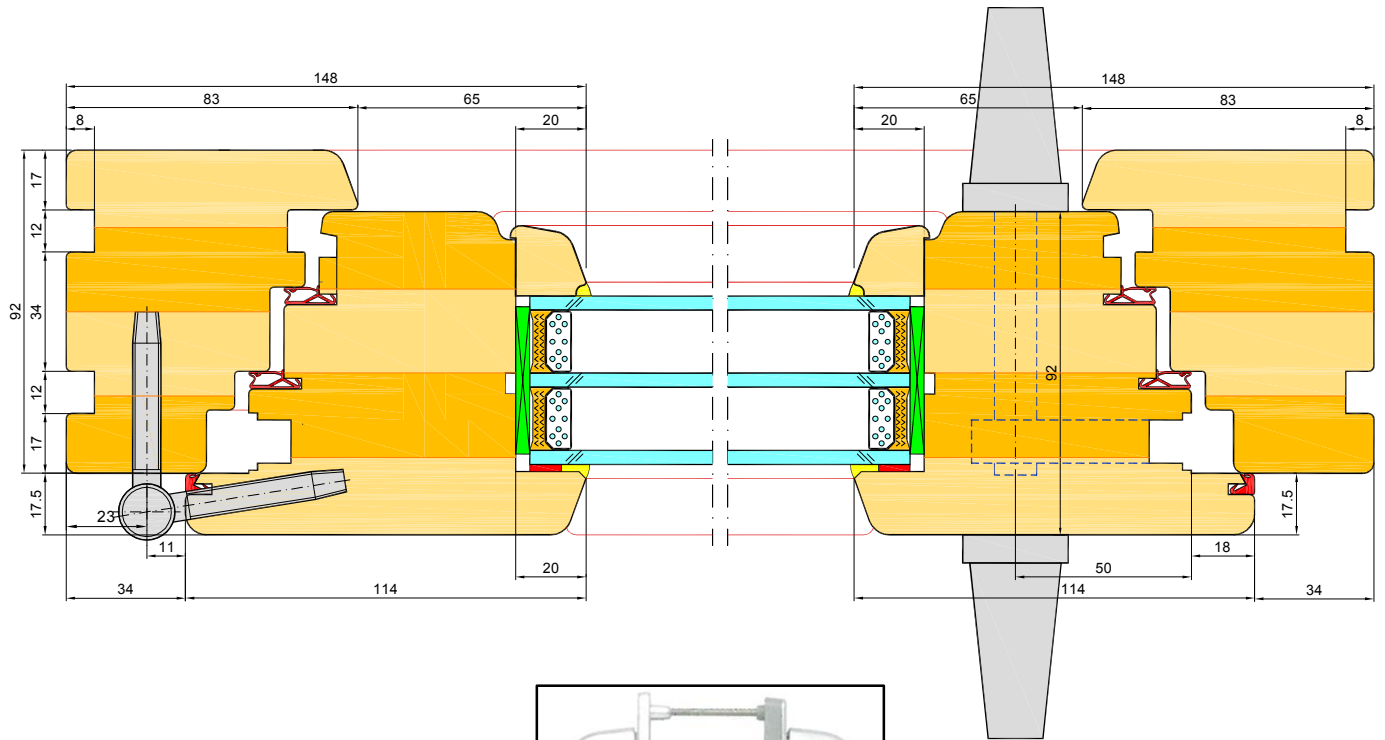

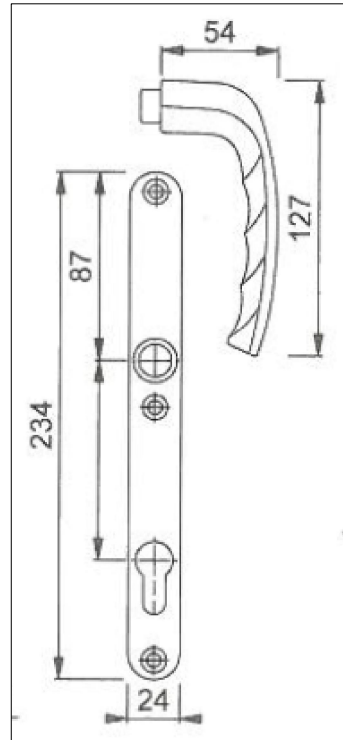
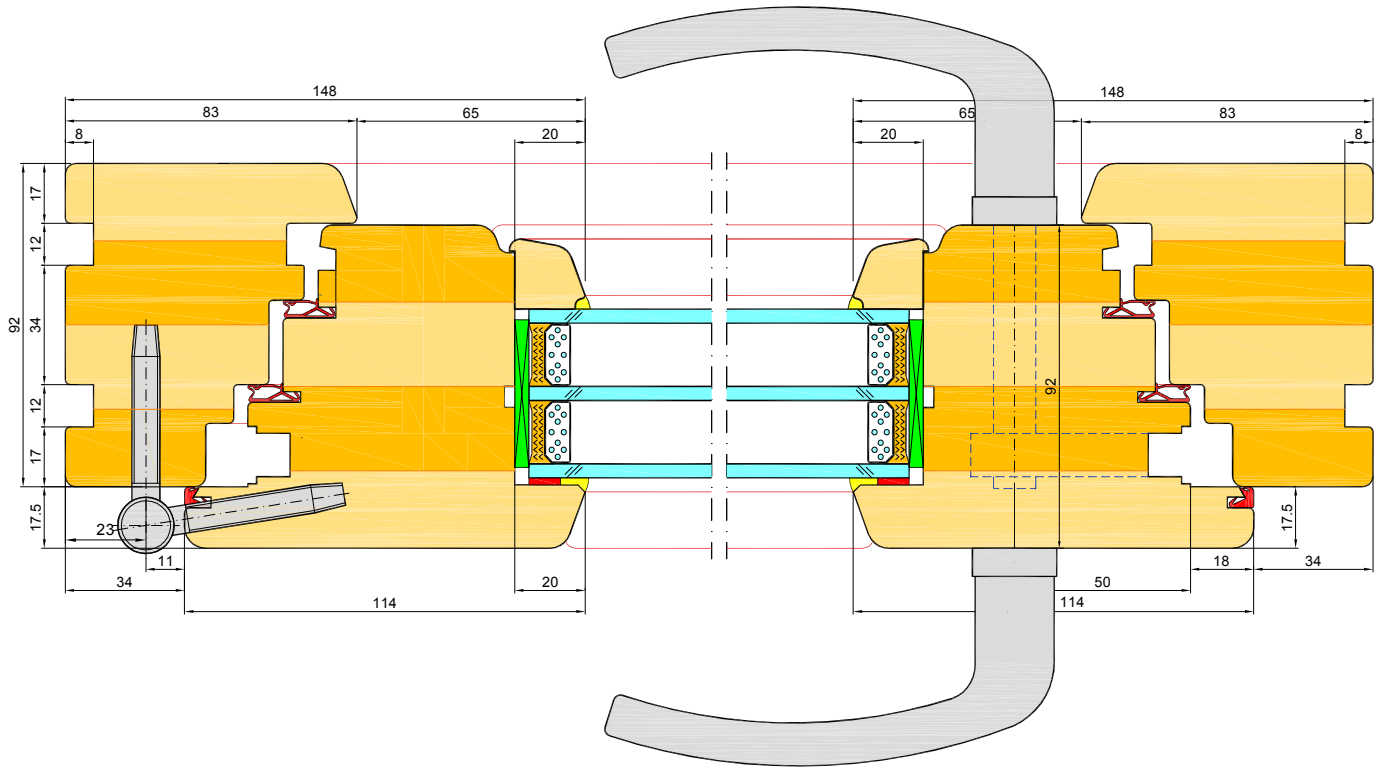

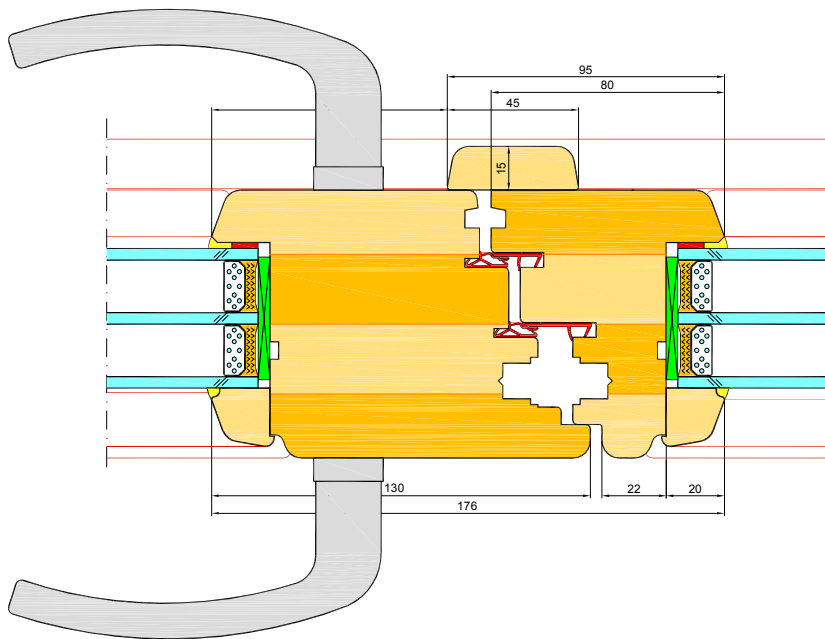

Double sash balcony doors with flying mullion

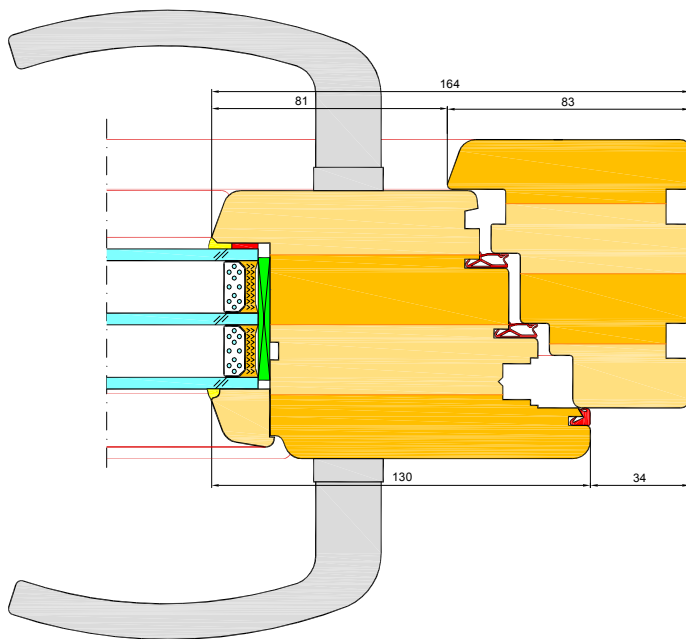

Single sash balcony doors

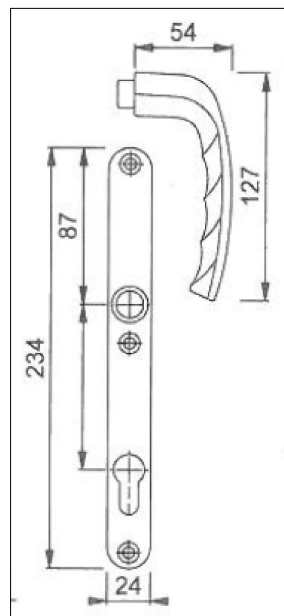

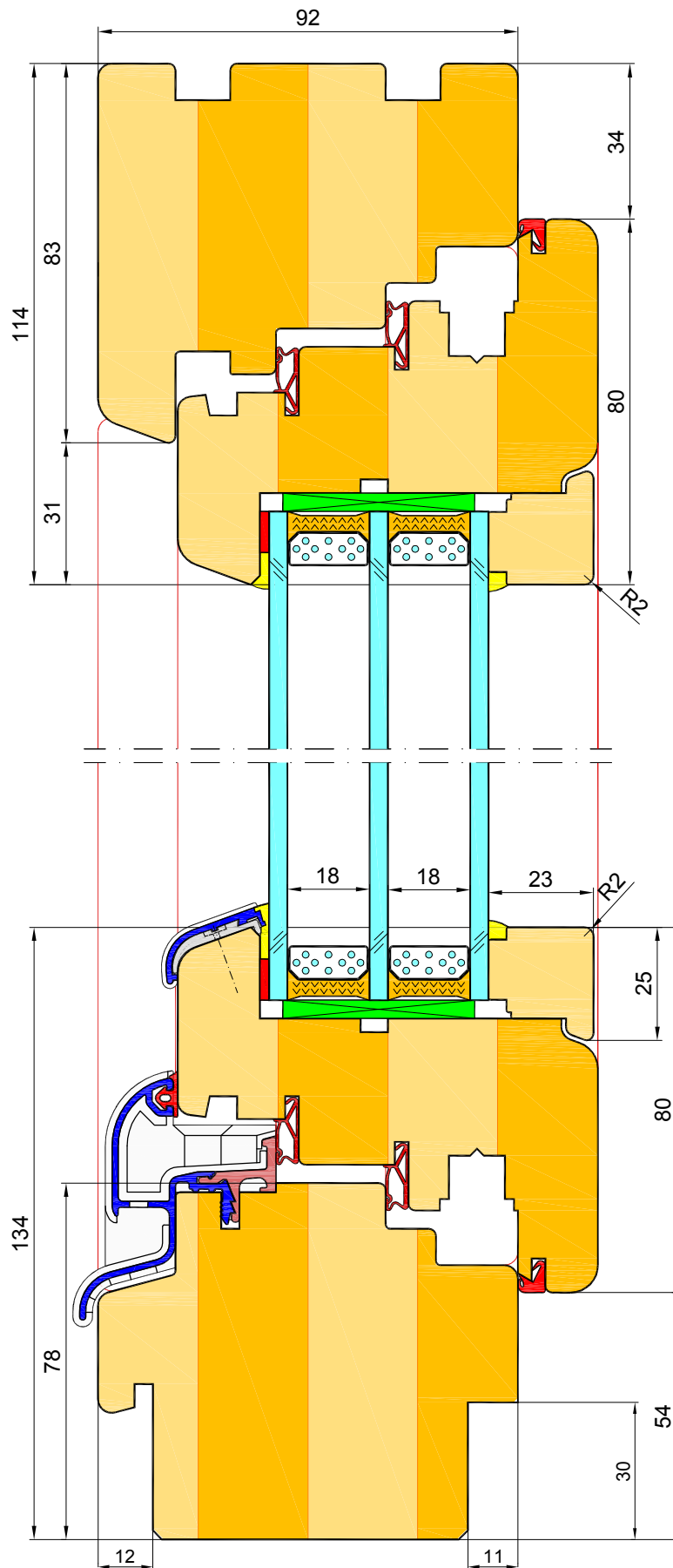

ELITE 92 - Threshold

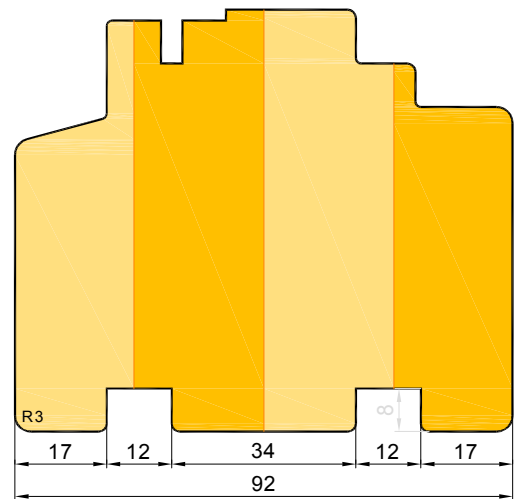
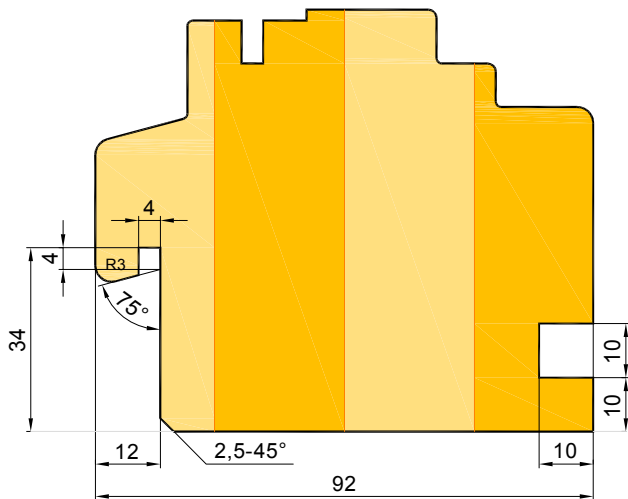
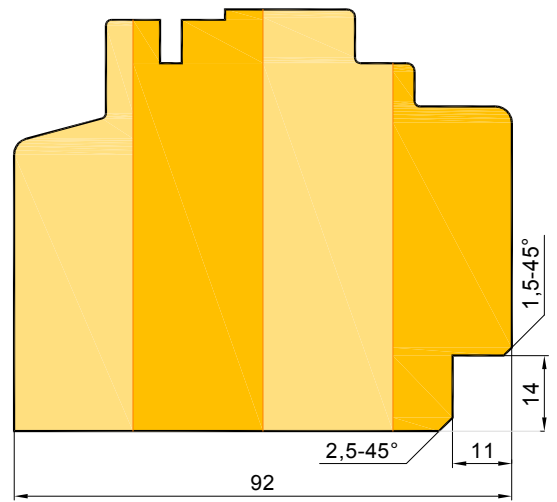
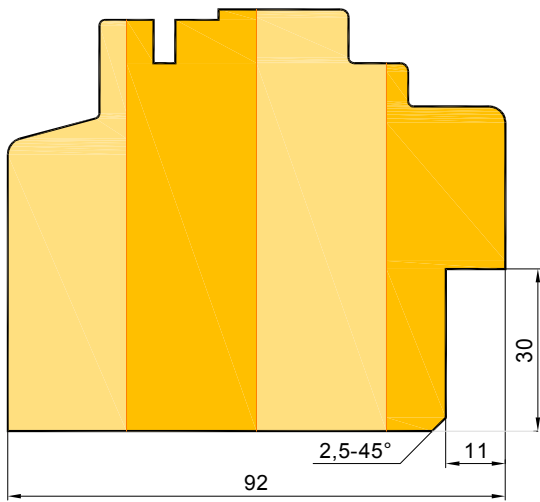
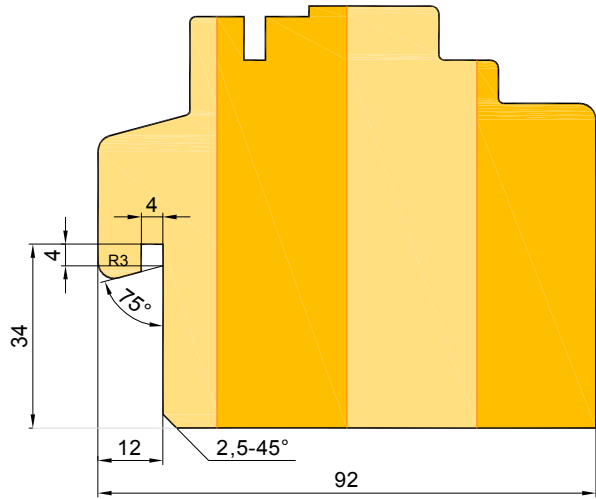
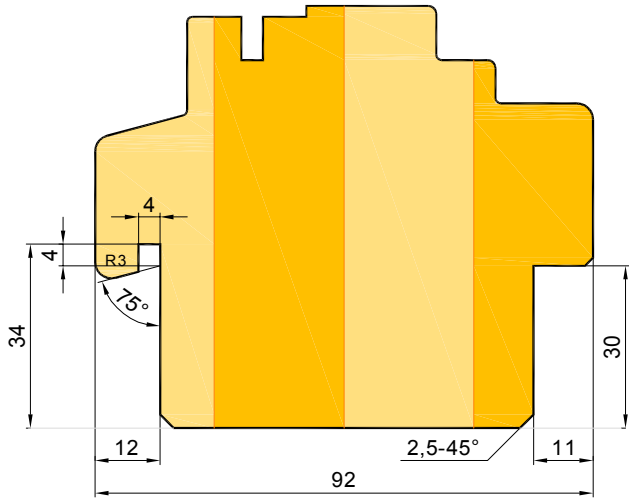

CONNECTOR

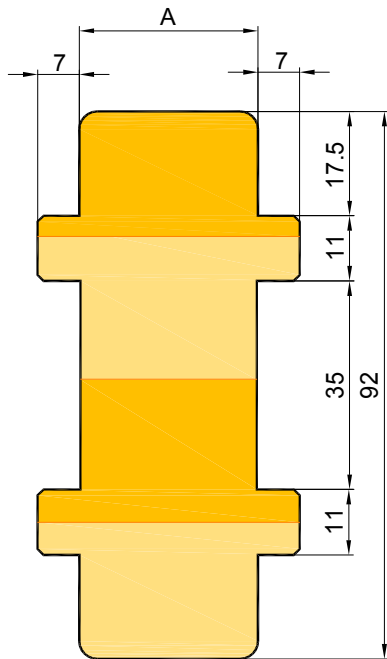

- size A: from 20mm to 130mm

WIDENING

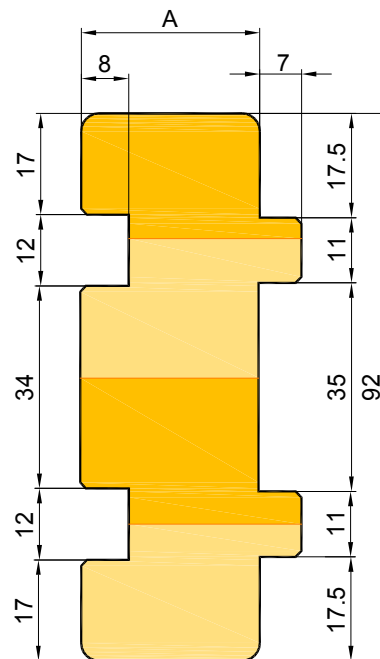

- size A: from 20mm to 130mm

Corner connector 90°

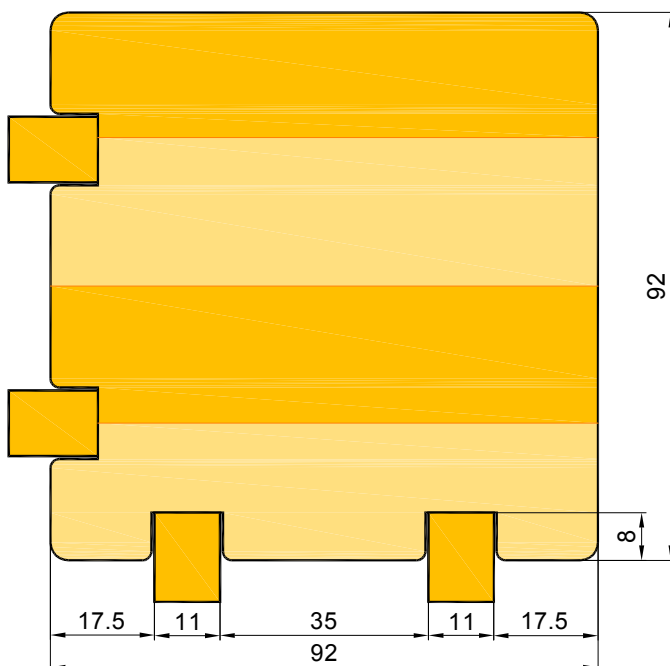

Corner connector 135°

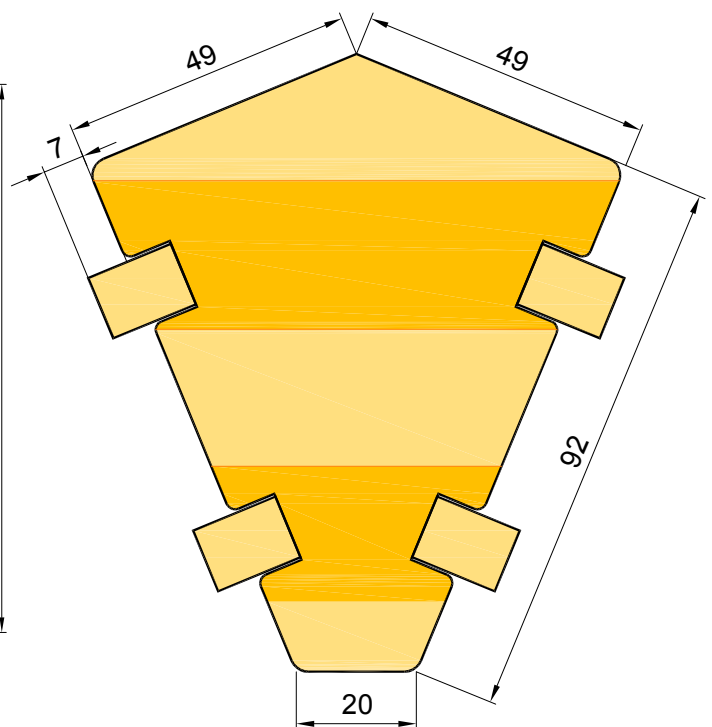

Window connection

without temporary glazing



with temporary glazing

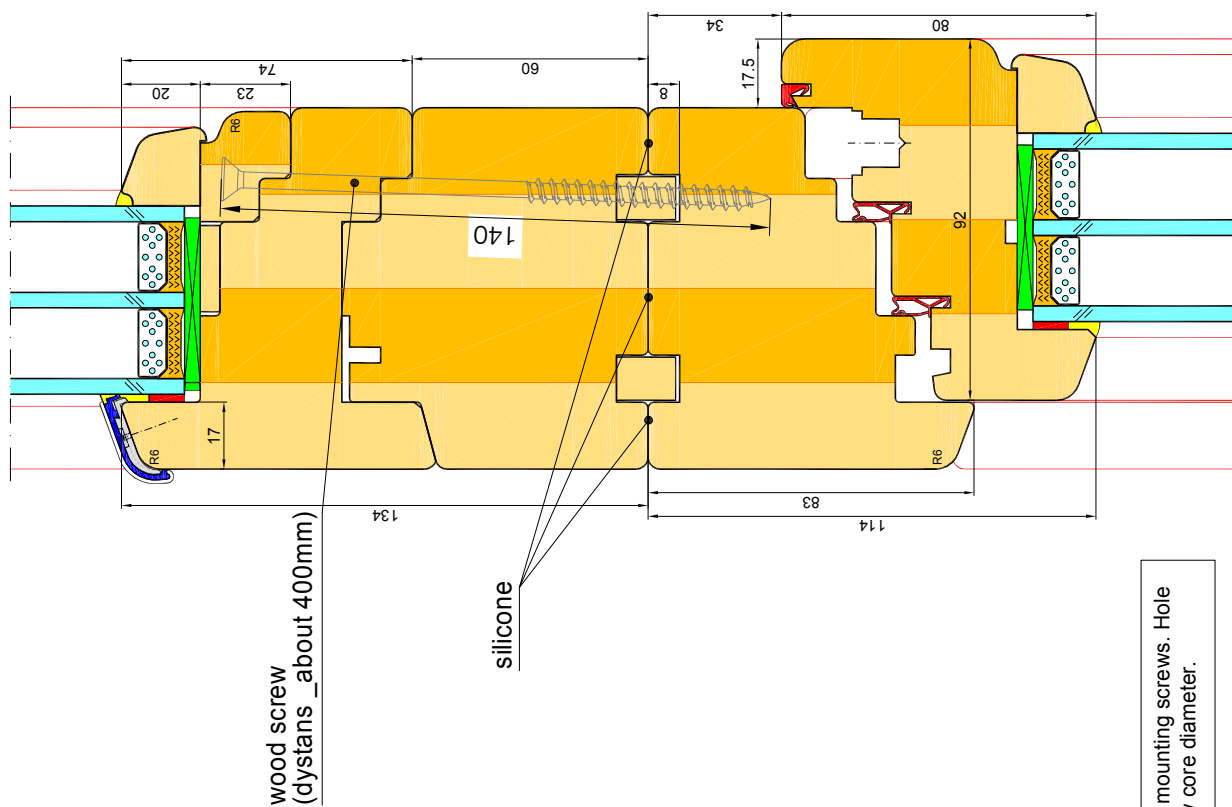

NOTE: make drilling for mounting screws. Hole diameter equal to screw core diameter.

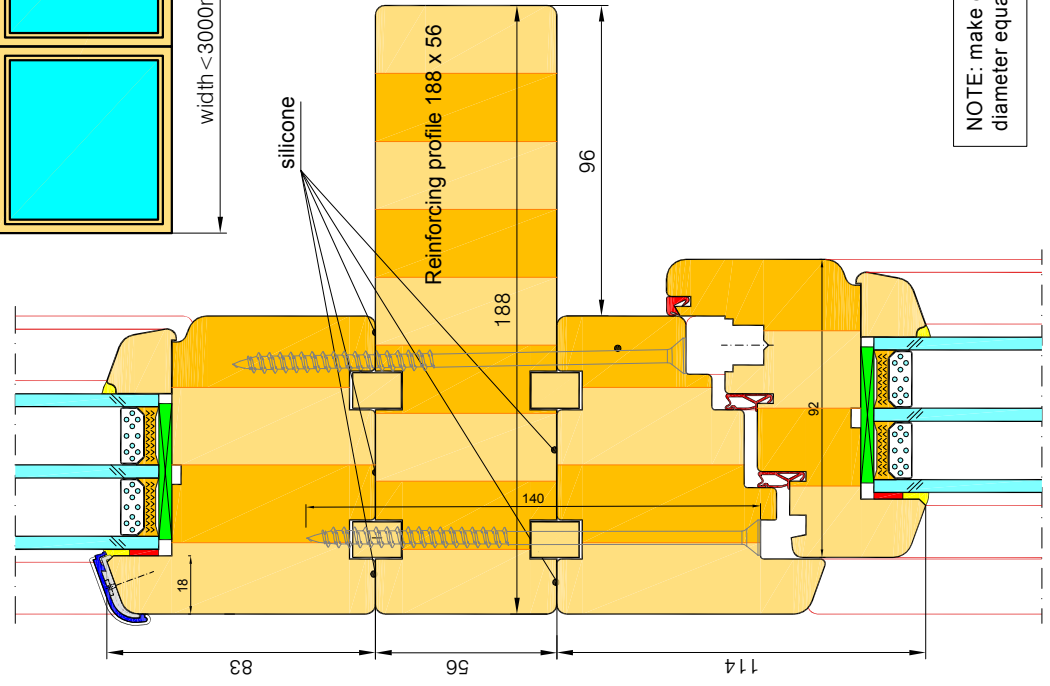
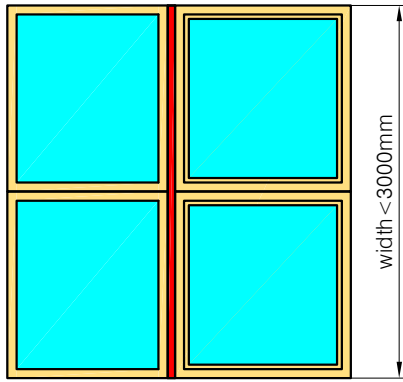
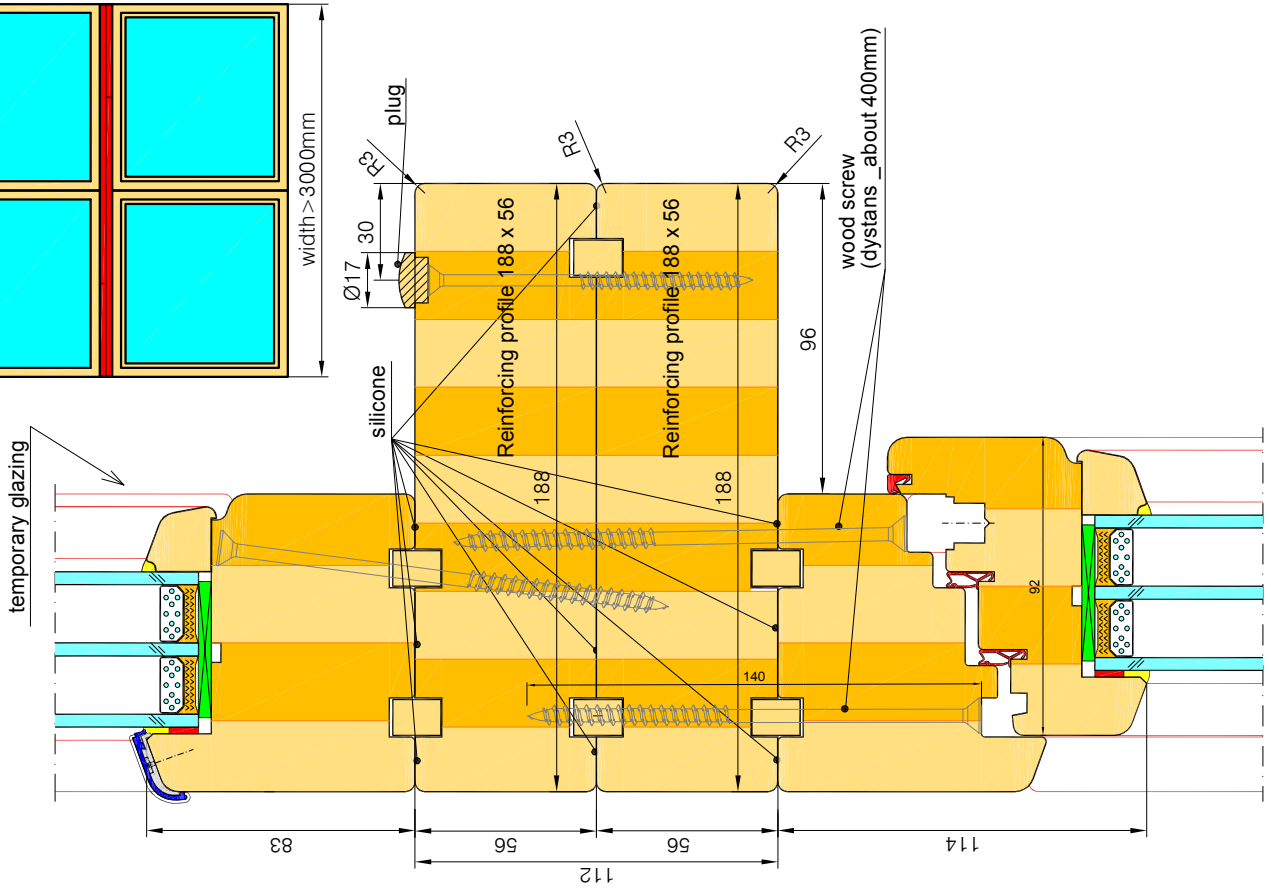
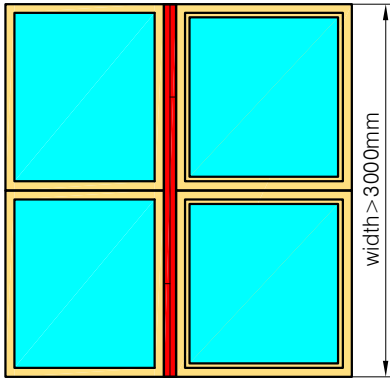

Reinforcing profile for window set (188 x 56mm).

NOTE: make drilling for mounting screws. Hole diameter equal to screw core diameter.

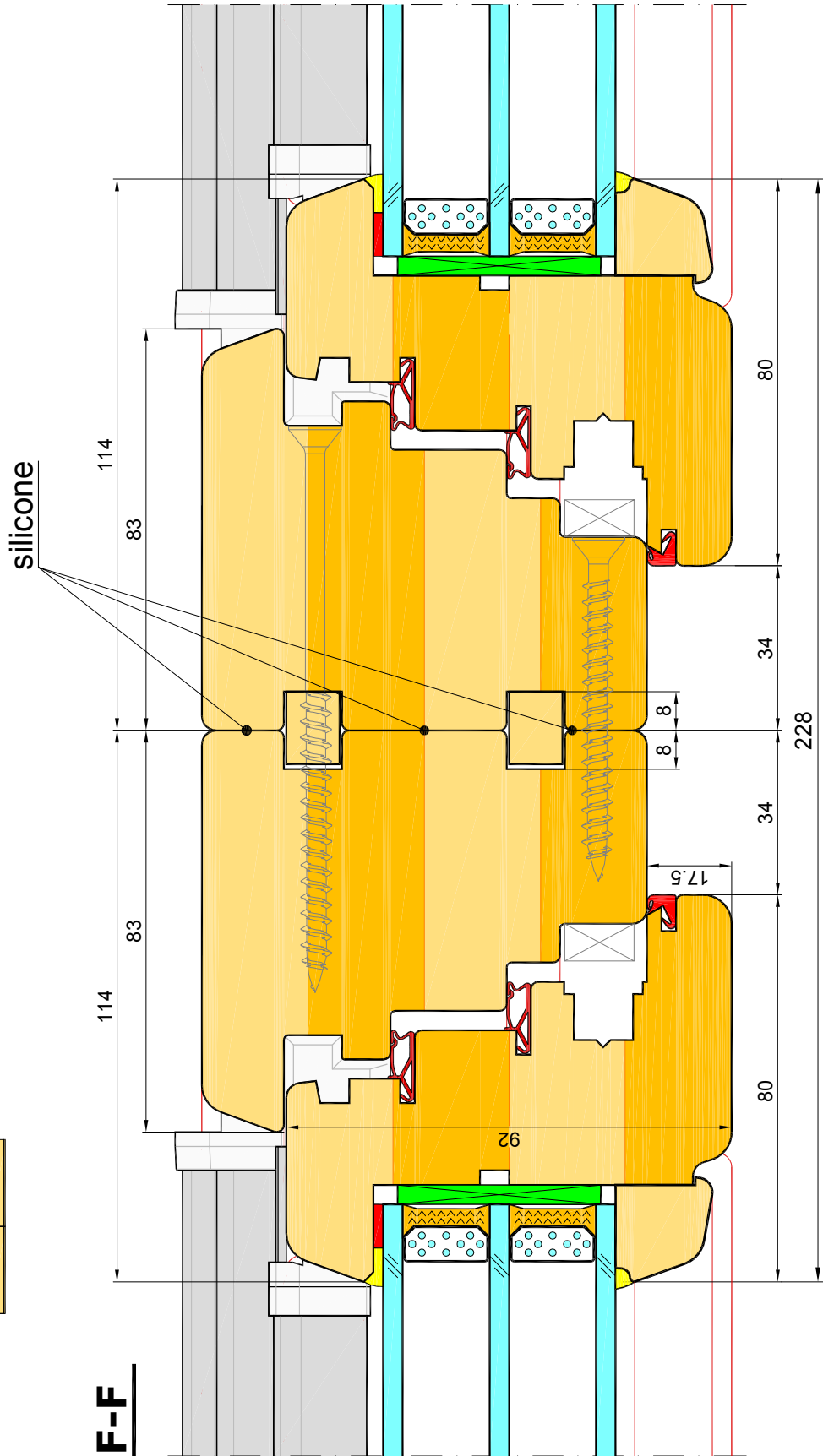
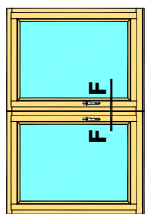

NOTE: make drilling for mounting screws. Hole diameter equal to screw core diameter.

ELITE 92 - Mounting holes. Adjufix.

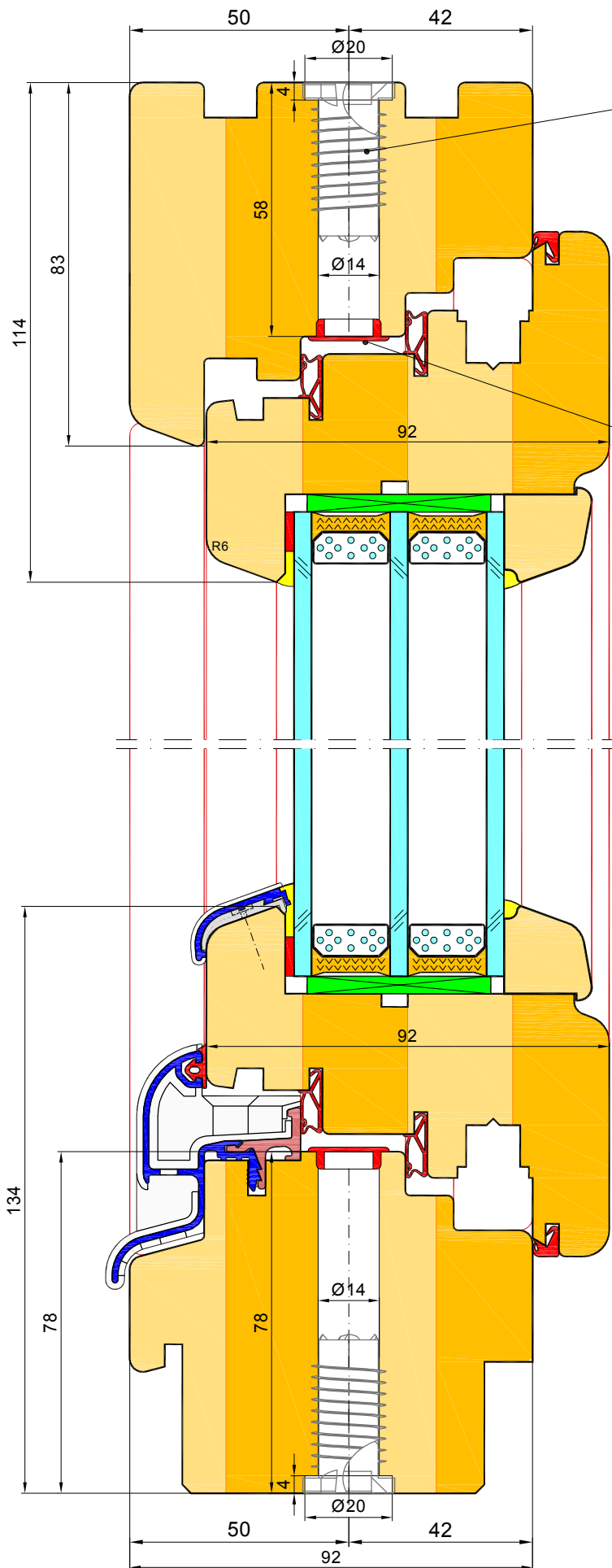

Adjufix

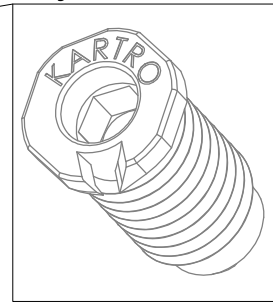

PVC plug

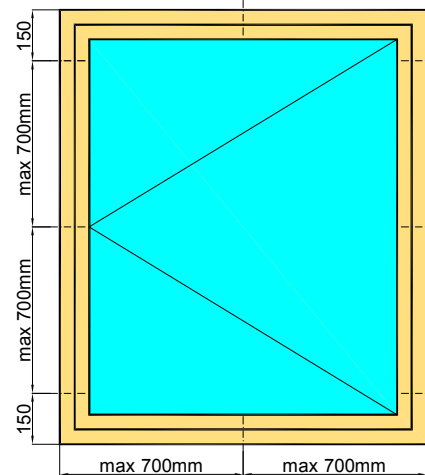
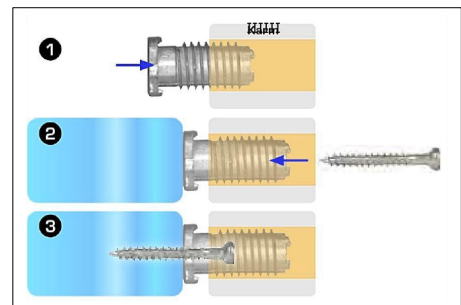
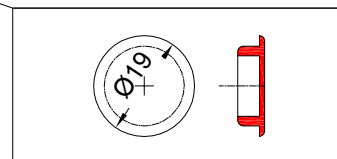

Location of the EMM vent in the window cross section.

